



HTR-5450RDS

Natural Sound AV Receiver
Ampli-tuner audio-vidéo

OWNER'S MANUAL
MODE D'EMPLOI
BEDIENUNGSANLEITUNG
BRUKSANVISNING
MANUALE DI ISTRUZIONI
MANUAL DE INSTRUCCIONES
GEBRUIKSAANWIJZING

CAUTION: READ THIS BEFORE OPERATING YOUR UNIT.

- 1 To assure the finest performance, please read this manual carefully. Keep it in a safe place for future reference.
- 2 Install this unit in a well ventilated, cool, dry, clean place with at least 30 cm on the top, 20 cm on the right and left, and 10 cm at the back of this unit for ventilation space — away from direct sunlight, heat sources, vibration, dust, moisture, and/or cold.
- 3 Locate this unit away from other electrical appliances, motors, or transformers to avoid humming sounds. To prevent fire or electrical shock, do not place this unit where it may get exposed to rain, water, and/or any type of liquid.
- 4 Do not expose this unit to sudden temperature changes from cold to hot, and do not locate this unit in a environment with high humidity (i.e. a room with a humidifier) to prevent condensation inside this unit, which may cause an electrical shock, fire, damage to this unit, and/or personal injury.
- 5 On the top of this unit, do not place:
 - Other components, as they may cause damage and/or discoloration on the surface of this unit.
 - Burning objects (i.e. candles), as they may cause fire, damage to this unit, and/or personal injury.
 - Containers with liquid in them, as they may cause electrical shock to the user and/or damage to this unit.
- 6 Do not cover this unit with a newspaper, tablecloth, curtain, etc. in order not to obstruct heat radiation. If the temperature inside this unit rises, it may cause fire, damage to this unit, and/or personal injury.
- 7 Do not plug in this unit to a wall outlet until all connections are complete.
- 8 Do not operate this unit upside-down. It may overheat, possibly causing damage.
- 9 Do not use force on switches, knobs and/or cords.
- 10 When disconnecting the power cord from the wall outlet, grasp the plug; do not pull the cord.
- 11 Do not clean this unit with chemical solvents; this might damage the finish. Use a clean, dry cloth.
- 12 Only voltage specified on this unit must be used. Using this unit with a higher voltage than specified is dangerous and may cause fire, damage to this unit, and/or personal injury. YAMAHA will not be held responsible for any damage resulting from use of this unit with a voltage other than specified.
- 13 To prevent damage by lightning, disconnect the power cord from the wall outlet during an electrical storm.
- 14 Take care of this unit so that no foreign objects and/or liquid drops inside this unit.
- 15 Do not attempt to modify or fix this unit. Contact qualified YAMAHA service personnel when any service is needed. The cabinet should never be opened for any reasons.
- 16 When not planning to use this unit for long periods of time (i.e. vacation), disconnect the AC power plug from the wall outlet.
- 17 Be sure to read the “TROUBLESHOOTING” section on common operating errors before concluding that this unit is faulty.
- 18 Before moving this unit, press **STANDBY/ON** to set this unit in the standby mode, and disconnect the AC power plug from the wall outlet.

This unit is not disconnected from the AC power source as long as it is connected to the wall outlet, even if this unit itself is turned off. This state is called the standby mode. In this state, this unit is designed to consume a very small quantity of power.

■ For U.K. customers

If the socket outlets in the home are not suitable for the plug supplied with this appliance, it should be cut off and an appropriate 3 pin plug fitted. For details, refer to the instructions described below.

Note

- The plug severed from the mains lead must be destroyed, as a plug with bared flexible cord is hazardous if engaged in a live socket outlet.

■ Special Instructions for U.K. Model

IMPORTANT

THE WIRES IN MAINS LEAD ARE COLOURED IN ACCORDANCE WITH THE FOLLOWING CODE:

Blue: NEUTRAL

Brown: LIVE

As the colours of the wires in the mains lead of this apparatus may not correspond with the coloured markings identifying the terminals in your plug, proceed as follows:

The wire which is coloured BLUE must be connected to the terminal which is marked with the letter N or coloured BLACK. The wire which is coloured BROWN must be connected to the terminal which is marked with the letter L or coloured RED.

Making sure that neither core is connected to the earth terminal of the three pin plug.



CONTENTS

INTRODUCTION

FEATURES	2
GETTING STARTED	3
Checking the Package Contents	3
Battery Installation in the Remote Control	3
Battery Replacement	3
CONTROLS AND FUNCTIONS	4
Front Panel	4
Remote Control	6
Using the Remote Control	7
Display	8
Rear Panel	9

PREPARATION

SPEAKER SETUP	10
Speakers to Be Used	10
Speaker Placement	10
CONNECTIONS	11
Before Connecting Components	11
Connecting Audio Components	12
Connecting an External Decoder	12
Connecting Video Components	14
Connecting Speakers	16
IMPEDANCE SELECTOR Switch	18
Connecting the Power Supply Cords	18
ADJUSTING THE SPEAKER BALANCE	19
Before You Start Adjusting	19
Using the Test Tone	19

BASIC OPERATION

PLAYING A SOURCE	21
Input Modes and Indications	23
Selecting a DSP Program	24
Canceling the Sound Effect (turning off the effect speakers)	25
TUNING	26
Connecting the Antennas	26
Automatic Tuning	27
Manual Tuning	27
Automatic Preset Tuning (for RDS stations only)	28
Manual Preset Tuning	29
To Recall a Preset Station	29
Exchanging Preset Stations	30
RECEIVING RDS STATIONS	31
Description of RDS Data	31
Changing the RDS Mode	31
PTY SEEK Function	32
EON Function	33
RECORDING A SOURCE	34

ADVANCED OPERATION

SET MENU	35
Adjusting the Items on the SET MENU	35
1 SPEAKER SET (speaker mode settings)	36
2 HP TONE CTRL (headphone tone control)	37
3 I/O ASSIGN	37
4 INPUT MODE (initial input mode)	38
5 DOLBY D. SET (Dolby Digital set)	38
6 DTS SET (DTS LFE level)	38
7 SP DLY TIME (center delay)	39
8 DISPLAY SET	39
9 MEM. GUARD (memory guard)	39
DELAY TIME AND SPEAKER OUTPUT LEVELS	40
Delay Time	40
Sound Output Level of the Center, Right Rear and Left Rear Speakers, and Subwoofer	40
Adjusting Method	41
SLEEP TIMER	42
Setting the SLEEP Timer	42
Canceling the SLEEP Timer	42
PRESET REMOTE CONTROL	43
Component Selector Buttons	43
Controlling the Components Connected to This Unit	43
Description of Each Mode	44
Setting the Manufacturer Code	48
Returning to the Factory Setting	49
SOUND FIELD PROGRAM	50
Hi-Fi DSP Programs	50
CINEMA DSP Programs	50

APPENDIX

TROUBLESHOOTING	53
SPECIFICATIONS	57
GLOSSARY	58
INDEX	60



FEATURES

5-Channel Power Amplification

- ◆ Minimum RMS Output
(0.06% THD, 20 Hz – 20 kHz)
Main: 70 W + 70 W (8 Ω)
Center: 70 W (8 Ω)
Rear: 70 W + 70 W (8 Ω)

Multi-mode Digital Sound Field Processing

- ◆ DTS Decoder
- ◆ Dolby Pro Logic Decoder
- ◆ Dolby Digital Decoder
- ◆ Hi-Fi DSP
- ◆ CINEMA DSP: Combination of YAMAHA DSP Technology and Dolby Digital, Dolby Pro Logic or DTS
- ◆ Virtual CINEMA DSP
- ◆ SILENT CINEMA

Sophisticated FM/AM Tuner

- ◆ 40-Station Random Access Preset Tuning
- ◆ Automatic Preset Tuning
- ◆ Preset Station Shifting Capability (Preset Editing)
- ◆ Multi-Functions for RDS Broadcast Reception

Other Features

- ◆ 96-kHz/24-bit D/A Converter
- ◆ “SET MENU” which Provides You with 9 Items for Optimizing This Unit for Your Audio/Video System
- ◆ Test Tone Generator for Easier Speaker Balance Adjustment
- ◆ 6-Channel External Decoder Input for Other Future Formats
- ◆ Video Signal Input and Output Capability (Including S Video Connections)
- ◆ Optical and Coaxial Digital Signal Input Jacks
- ◆ SLEEP Timer
- ◆ Remote Control with Preset Manufacturer Codes

-  indicates a tip for your operation.
- Some operations can be performed by using either the buttons on the main unit or on the remote control. In cases when the button names differ between the main unit and the remote control, the button name on the remote control is given in parentheses in this manual.



Manufactured under license from Dolby Laboratories.

“Dolby”, “AC-3”, “Pro Logic” and the double-D symbol are trademarks of Dolby Laboratories.
Confidential Unpublished Works. ©1992-1997 Dolby Laboratories, Inc. All rights reserved.



Manufactured under license from Digital Theater Systems, Inc. US Pat. No. 5,451,942 and other world-wide patents issued and pending. “DTS” and “DTS Digital Surround” are trademarks of Digital Theater Systems, Inc. Copyright 1996 Digital Theater Systems, Inc. All Rights Reserved.



GETTING STARTED

Checking the Package Contents

Check that the following items are included in your package.

Remote control

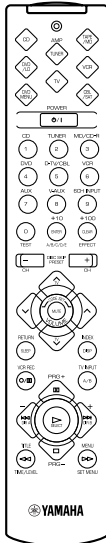

Batteries (AAA, R03, UM-4 type)

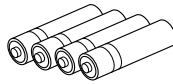

AM loop antenna

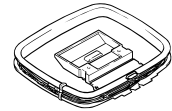

Indoor FM antenna

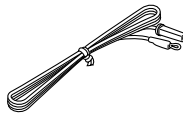

Quick reference card

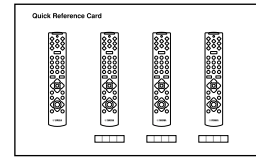

75-ohm/300-ohm antenna adapter (U.K. model only)

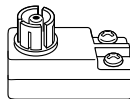

Connection guide

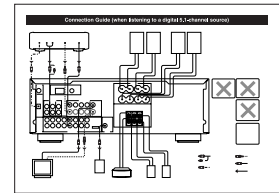

Battery Installation in the Remote Control

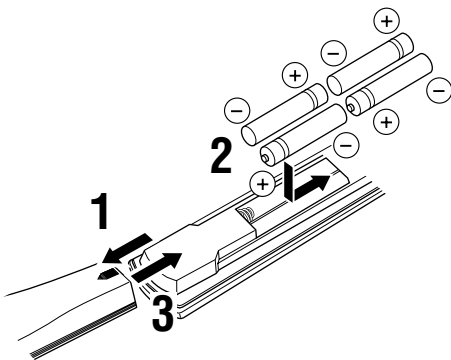

Battery Replacement

If the remote control operates only when it is close to the unit, the batteries are weak. Replace all the batteries with new ones.

Be sure to replace the batteries within about two minutes. If it takes longer than two minutes, the codes preset for the remote control will return to the factory settings.

Notes

- Use only AAA, R03 or UM-4 batteries for replacement.
- Be sure the battery polarity is correct. (See the illustration inside the battery compartment.)
- Remove the batteries if the remote control will not be used for an extended period of time.
- If the batteries have leaked, dispose of them immediately. Avoid touching the leaked material or letting it come into contact with clothing, etc. Clean the battery compartment thoroughly before installing new batteries.

- 1** Turn the remote control over and slide the battery compartment cover in the direction of the arrow.
- 2** Insert the batteries (AAA, R03 or UM-4 type) according to the polarity markings on the inside of the battery compartment.
- 3** Close the battery compartment cover.



CONTROLS AND FUNCTIONS

Front Panel

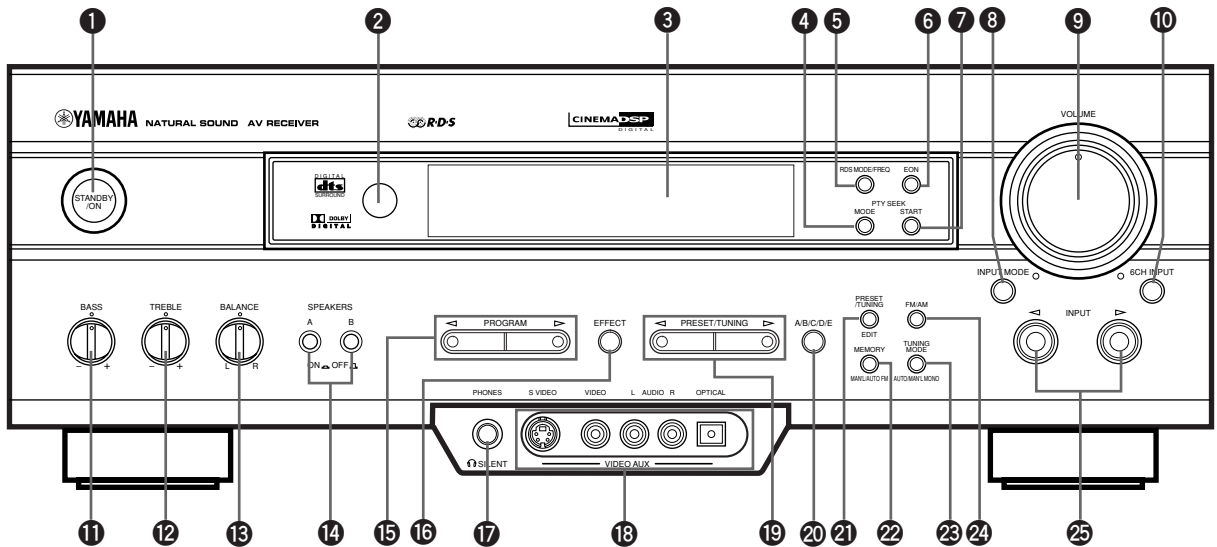

1 STANDBY/ON

Press this switch to turn on the power of this unit or to set this unit in the standby mode. Before turning the power on, set the volume at the minimum level.

Standby mode

In this mode, this unit consumes a very small quantity of power to receive infrared-signals from the remote control.

2 Remote control sensor

This receives signals from the remote control.

3 Display

This shows various information.

4 PTY SEEK MODE

Press this button to set the unit in the PTY SEEK mode.

5 RDS MODE/FREQ

When an RDS station is received, press this button to change the display mode among the PS mode, PTY mode, RT mode, CT mode (if the station offers those RDS data services) and/or frequency display mode in turn.

6 EON

Press this button to select the desired program type (NEWS, INFO, AFFAIRS, SPORT) when you want to tune in to a radio program of that type automatically.

7 PTY SEEK START

Press this button to begin searching for a station after the desired program type has been selected in the PTY SEEK mode.

8 INPUT MODE

Press this button to select the input mode among AUTO, DTS and ANALOG for the sources that send two or more types of signals to this unit.

9 VOLUME

Turn this control to turn up or down the volume.

10 6CH INPUT

Press this button to select the source connected to the 6CH INPUT jacks. The source selected by pressing 6CH INPUT takes priority over the source selected with INPUT </> (or the input selector buttons on the remote control).

11 BASS

Turn this control clockwise to increase or counterclockwise to decrease the low-frequency response.

12 TREBLE

Turn this control clockwise to increase or counterclockwise to decrease the high-frequency response.

Note

- If you increase or decrease the high-frequency or the low-frequency sound to an extreme level, the tonal quality from the center and rear speakers may not match that of the left and right main speakers.

13 BALANCE

This control is only effective for the sound from the main speakers.

Turn the control to adjust the balance of the output volume from the right and left main speakers to compensate for sound imbalance caused by the speaker location or listening room conditions.

14 SPEAKERS A/B

Set A or B (or both A and B) to the ON position for the main speaker system (connected to this unit) that you want to use. Set the button(s) to the OFF position for the main speaker system that you don't want to use.

15 PROGRAM </>

Press < or > to select a DSP program when the effect speakers (center and rear) are turned on. The name of the selected program appears on the display.

16 EFFECT

Press this button to turn on or off the effect speakers (center and rear). If you turn them off, all Dolby Digital and DTS audio signals except for the LFE channel are directed to the right and left main speakers. In that case, the output levels of the right and left speakers may not match.

17 PHONES jack

Connect the headphones to the PHONES jack so that this unit outputs audio signals for private listening.

When listening with headphones privately, set both SPEAKERS A/B to the OFF position.

18 VIDEO AUX jacks

Connect an auxiliary audio or video input source such as a game console to these jacks. To reproduce source signals from these jacks, select V-AUX as the input source.

19 PRESET/TUNING </>

When “>” appears on the display:

This button is used to select a preset station number (1 to 8). Press < to select a lower and > to select a higher preset station number.

When “>” goes off from the display:

This button is used for tuning. Press < to tune in to lower frequencies, and > to tune in to higher frequencies.

When this unit is in the PTY SEEK mode, press this button to select a program type.

20 A/B/C/D/E

Press this button to select one of 5 preset station groups (A to E).

21 PRESET/TUNING (EDIT)

Press this button to turn on or off “>” on the display and switch the function between for storing a broadcasting station (preset tuning) and for tuning. This button is also used to exchange the assignment of two preset stations with each other.

22 MEMORY (MAN'L/AUTO FM)

Press this button to store the broadcasting stations. Hold down this button for more than 3 seconds to begin automatic preset tuning (for FM stations only).

23 TUNING MODE (AUTO/MAN'L MONO)

Press this button to switch the tuning mode between automatic and manual. To use the automatic tuning method, press this button so that the “AUTO” indicator lights up on the display. To use the manual tuning method, press this button so that the “AUTO” indicator goes off.

24 FM/AM

Press this button to switch the reception band between FM and AM.

25 INPUT </>

Press these buttons to select the input source (DVD, AUX, MD/CD-R, TUNER, CD, V-AUX, VCR, D-TV/CBL) that you want to listen to or watch. The name of the selected input source appears on the display.

Remote Control

This section describes basic operation of this unit with the remote control. First, press AMP(TUNER) on the component selector. Refer to “PRESET REMOTE CONTROL” for full details.

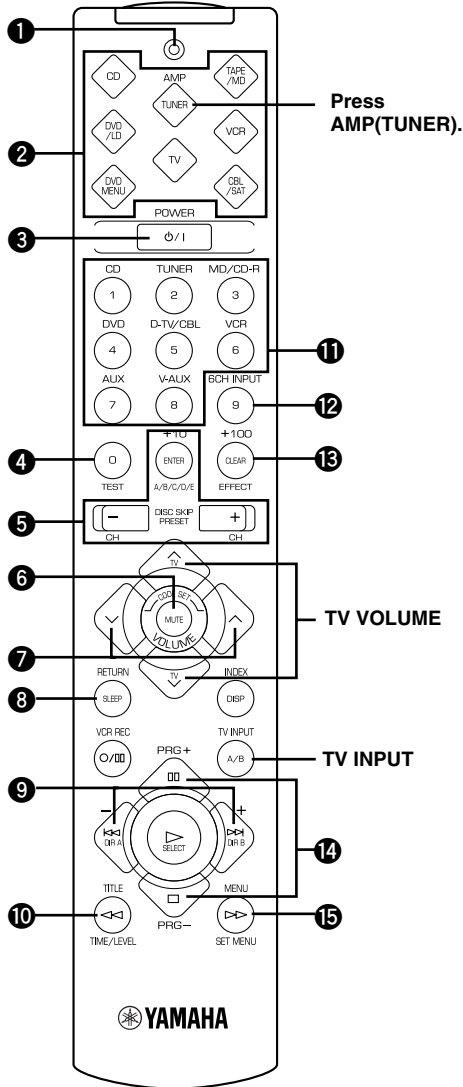

1 Indicator

This flashes in red when pressing a button on the remote control. If it flashes rapidly several times, press the selected button again.

2 Component selector buttons

Press one of these buttons which corresponds to the component you want to control with the remote control. (The proper code must be set for your component. Refer to “Setting the Manufacturer Code”.) When the component selector button has been pressed, the remote control is set to that component operation mode.

3 POWER

Each time you press this button, the unit switches between the power on and standby mode.

4 TEST

Press this button to output the test tone for each speaker.

5 A/B/C/D/E, PRESET -/+

These buttons are used to select a preset station.

A/B/C/D/E: To select one of a group (A to E) of preset stations

PRESET -/+: To select a preset station number (1 to 8)

6 MUTE

Press this button to mute the sound. To cancel mute, press this button again.

7 VOLUME

These buttons are used to adjust the volume level.

∧: To turn up the volume

∨: To turn down the volume

8 SLEEP

Press this button to set the SLEEP timer.

9 -/+

These buttons adjust the settings of the SET MENU and TIME/LEVEL mode.

10 TIME/LEVEL

Press this button to select the items in the TIME/LEVEL mode.

11 Input selector buttons

These buttons select the input source.

CD: To play a CD

TUNER: To listen to an FM (RDS) or AM broadcast

MD/CD-R: To play an MD or CD recorder (or tape deck)

DVD: To play a DVD

D-TV/CBL: To watch a TV/digital TV or cable TV

VCR: To play a video cassette

AUX: To use another audio component

V-AUX: To use another audio/video component

12 6CH INPUT

Press this button to play a source connected to the 6CH INPUT jacks.

13 EFFECT

Press this button to turn on or off the effect speakers (center and rear).

14 PRG+, PRG-

Press these buttons to select a DSP program.

Once you press SET MENU, these buttons are used for selecting the SET MENU item.

15 SET MENU

Press this button to select the items in the SET MENU.

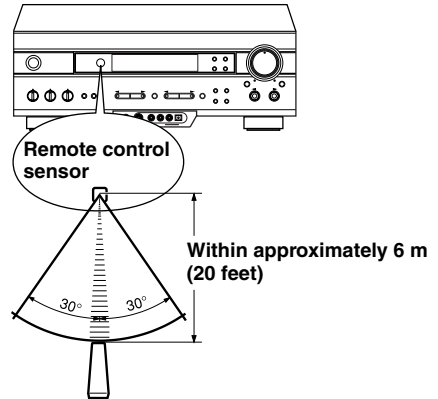
Using the Remote Control

The remote control transmits a directional infrared beam. Be sure to aim the remote control directly at the infrared sensor during operation. When the sensor is covered or there is a large object between the remote control and the sensor, the sensor cannot receive signals. The sensor may not be able to receive signals properly when it is exposed to direct sunlight or a strong artificial light (such as a fluorescent or strobe light). In this case, change the direction of the light or reposition the unit to avoid direct lighting.

Notes

- Handle the remote control with care.
- Do not spill water, tea or other liquids on the remote control.
- Do not drop the remote control.
- Do not leave or store the remote control in the following conditions:
 - high humidity or temperature such as near a heater, stove or bath;
 - dusty places; or
 - extremely low temperature.

Display

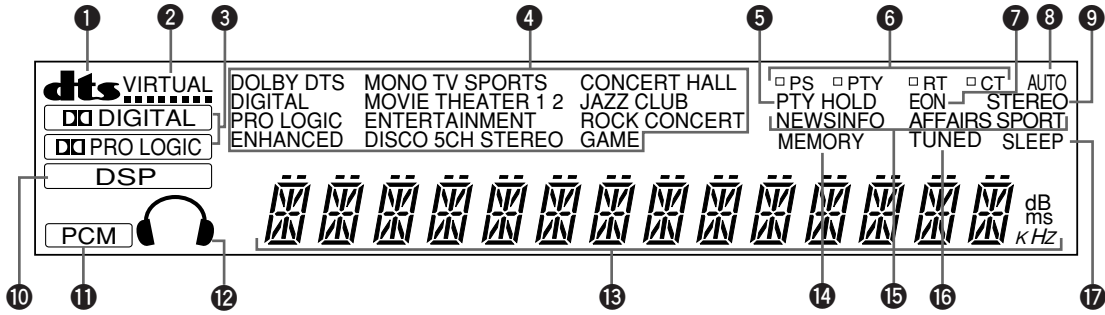

1 **dts** indicator

The “**dts**” indicator lights up when the built-in DTS decoder is turned on.

2 **VIRTUAL** indicator

This lights up when using Virtual CINEMA DSP.

3 **DIGITAL** and **PRO LOGIC** indicators

“**DIGITAL**” lights up when the built-in Dolby Digital decoder is on and the signals of the selected source are encoded with Dolby Digital. “**PRO LOGIC**” lights up when the built-in Dolby Pro Logic decoder is on.

4 **DSP** program indicators

This indicates the name of the selected DSP program.

5 **PTY HOLD** indicator

This lights up while searching for stations in the PTY SEEK mode.

6 **RDS mode indicators**

The name(s) of the RDS data offered by the currently received RDS station light(s) up. Illumination of the red indicator next to the RDS data name shows that the corresponding RDS mode is now selected.

7 **EON** indicator

This lights up when an RDS station that offers the EON data service is being received.

8 **AUTO** indicator

This lights up when the unit is in the automatic tuning mode.

9 **STEREO** indicator

This lights up when an FM stereo broadcast with sufficient signal strength is being received.

10 **DSP** indicator

“**DSP**” lights up when the built-in digital sound field processor is on.

11 **PCM** indicator

This lights up when this unit is reproducing PCM (pulse code modulation) digital audio signals.

12 **Headphones** indicator

This lights up when headphones are connected.

13 **Multi-information display**

This display shows various information: for example the name of the selected input source and the various settings during adjustment with the SET MENU. The current station frequency and band (FM or AM) also appear when the tuner is selected as the input source.

14 **MEMORY** indicator

This flashes for about 5 seconds after pressing MEMORY. During this period, the displayed station can be stored in the memory.

15 **Program type name indicators**

The name of the selected program type lights up when the “EON” indicator lights up.

16 **TUNED** indicator

This lights up when this unit tunes in to a station.

17 **SLEEP** indicator

This lights up while the built-in SLEEP timer is on.

Rear Panel

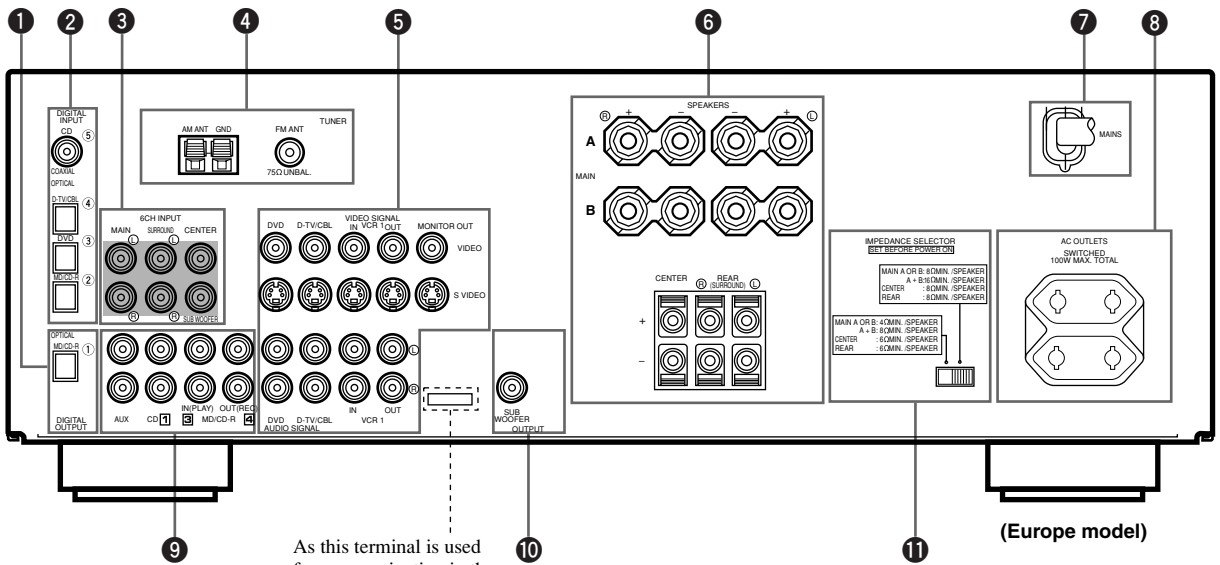

As this terminal is used for an examination in the factory, do not connect any equipment to this terminal.

1 DIGITAL OUTPUT jacks

2 DIGITAL INPUT jacks

3 6CH INPUT jacks

See pages 12 and 13 for connection information.

4 Antenna input terminals

See page 26 for connection information.

5 Video component jacks

See pages 14 and 15 for connection information.

6 Speaker terminals

See pages 16 and 17 for connection information.

7 AC power cord

Connect to a power outlet.

8 AC OUTLET(S)

Use these outlets to supply power to your other audio/video components (see page 18).

9 Audio component jacks

See pages 12 and 13 for connection information.

10 SUBWOOFER jack

See page 17 for connection information.

11 IMPEDANCE SELECTOR switch

Use this switch to match the amplifier output to your speaker impedance. Set this unit in the standby mode before you change the setting of this switch (see page 18).



SPEAKER SETUP

Speakers to Be Used

This unit is designed to provide the best sound-field quality with a 5-speaker system, using main speakers, rear speakers and a center speaker. If you use different brands of speakers (with different tonal qualities) in your system, the tone of a moving human voice and other types of sound may not shift smoothly. We recommend that you use speakers from the same manufacture to ensure even tonal quality.

The main speakers are used for the main source sound plus the effect sounds. They will probably be the speakers from your present stereo system. The rear speakers are used for the effect and surround sounds, and the center speaker is for the center sounds (dialog, vocals, etc.). If for some reason it is not practical to use a center speaker, you can do without it. Best results, however, are obtained with the full system.

The main speakers should be high-performance models and have enough power-handling capacity to accept the maximum output of your audio system. The other speakers do not have to be equal to the main speakers. For precise sound localization, however, it is ideal to use high-performance models that can reproduce sounds over the full range for the center speaker and the rear speakers.

■ Use of a subwoofer expands your sound field

It is also possible to further expand your system with the addition of a subwoofer. The use of a subwoofer is effective not only for reinforcing bass frequencies from any or all channels, but also for reproducing the LFE (low frequency effect) channel with high fidelity when playing back a source encoded with Dolby Digital or DTS. The YAMAHA Active Servo Processing Subwoofer System is ideal for natural and lively bass reproduction.

Speaker Placement

Refer to the following diagram when you place the speakers.

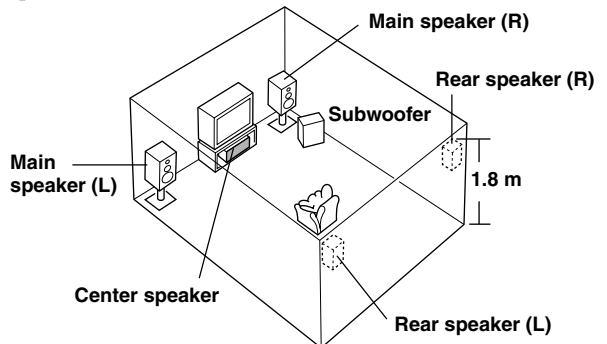

■ Main speakers

Place the right and left main speakers an equal distance from the ideal listening position. The distance of each speaker from each side of the TV monitor should be the same.

■ Rear speakers

Place these speakers behind your listening position, facing slightly inwards, nearly 1.8 m (approx. 6 feet) above the floor.

■ Center speaker

Align the front face of the center speaker with the front face of your TV monitor. Place the speaker as close to the monitor as possible, such as directly over or under the monitor and centrally between the main speakers.

Note

- If the center speaker is not used, the sound will be heard from the right and left main speakers. In that case, "CENTER SP" in the SET MENU is set to the NON position.

■ Subwoofer

The position of the subwoofer is not so critical, because low bass sounds are not highly directional. But it is better to place the subwoofer near the main speakers. Turn it slightly toward the center of the room to reduce the wall reflections.

CAUTION

Please use magnetically shielded speakers. Sometimes a video monitor may be adversely affected even when magnetically shielded speakers are used. Separate the speakers from the monitor if this happens.



CONNECTIONS

Before Connecting Components

CAUTION

Never connect this unit and other components to mains power until all connections between components have been completed.

Be sure all connections are made correctly, that is to say L (left) to L, R (right) to R, “+” to “+” and “-” to “-”. Some components require different connection methods and have different terminal names. Refer to the instructions for each component to be connected to this unit.

When you connect other YAMAHA audio components (such as a tape deck, MD recorder and CD player or changer), connect it to the jacks with the same number labels as **1**, **3**, **4** etc.

Use RCA-type pin plug cables for connecting audio/video components with the exception described later.

The input and output jacks for pin plugs can be distinguished as follows:

Yellow	video signals (composite)	
White	analog audio signals for the left channel	
Red	analog audio signals for the right channel	
	coaxial digital signals	

After completing all connections, check them again to make sure they are correct.

Connecting Audio Components

■ Connecting to digital jacks

This unit has digital jacks for direct transmission of digital signals through either coaxial or fiber optic cables. You can use the digital jacks to input PCM, Dolby Digital and DTS bitstreams. When you connect components to both the COAXIAL and OPTICAL jacks, priority is given to the input signals from the COAXIAL jack. All digital input jacks are acceptable for 96-kHz sampling digital signals.



- You can designate the input for each digital jack according to your component by using “3 I/O ASSIGN” in the SET MENU.

About the dust protection cap



Pull out the cap from the optical jack before you connect the fiber optic cable. Do not discard the cap. When you are not using the optical jack, be sure to put the cap back in place. This cap protects the jack from dust.

Note

- The OPTICAL jacks on this unit conform to the EIA standard. If you use a fiber optic cable that does not conform to this standard, this unit may not function properly.

■ Connecting a CD player



- The COAXIAL jack is available for a CD player which has coaxial digital output jack.
- When you connect a CD player to both the analog and digital jacks, priority is given to the input signals from the digital jack.

■ Connecting an MD recorder, CD recorder or tape deck



- When you connect your recording component to both the analog and digital input and output jacks, the priority is given to the digital signal.

Notes

- When you connect a recording component to this unit, keep its power on while using this unit. If the power is off, this unit may distort the sound from other components.
- Since digital output and analog output (REC OUT) are independent of each other, the analog signal is output only to the analog jack, while the digital signal is output only to the digital jack.

Connecting an External Decoder

This unit is equipped with 6 additional input jacks (left and right MAIN, CENTER, left and right SURROUND and SUBWOOFER) for discrete multi-channel input from an external decoder, sound processor or pre-amplifier.

Connect the output jacks on your external decoder to the 6CH INPUT jacks. Be sure to match the left and right outputs to the left and right input jacks for the main and surround channels.

Notes

- When you select 6CH INPUT as the input source, this unit automatically turns off the digital sound field processor, and you cannot listen to DSP programs.
- When you select 6CH INPUT as the input source, changing items of “1 SPEAKER SET” in the SET MENU is not affected (except “MAIN LVL”).

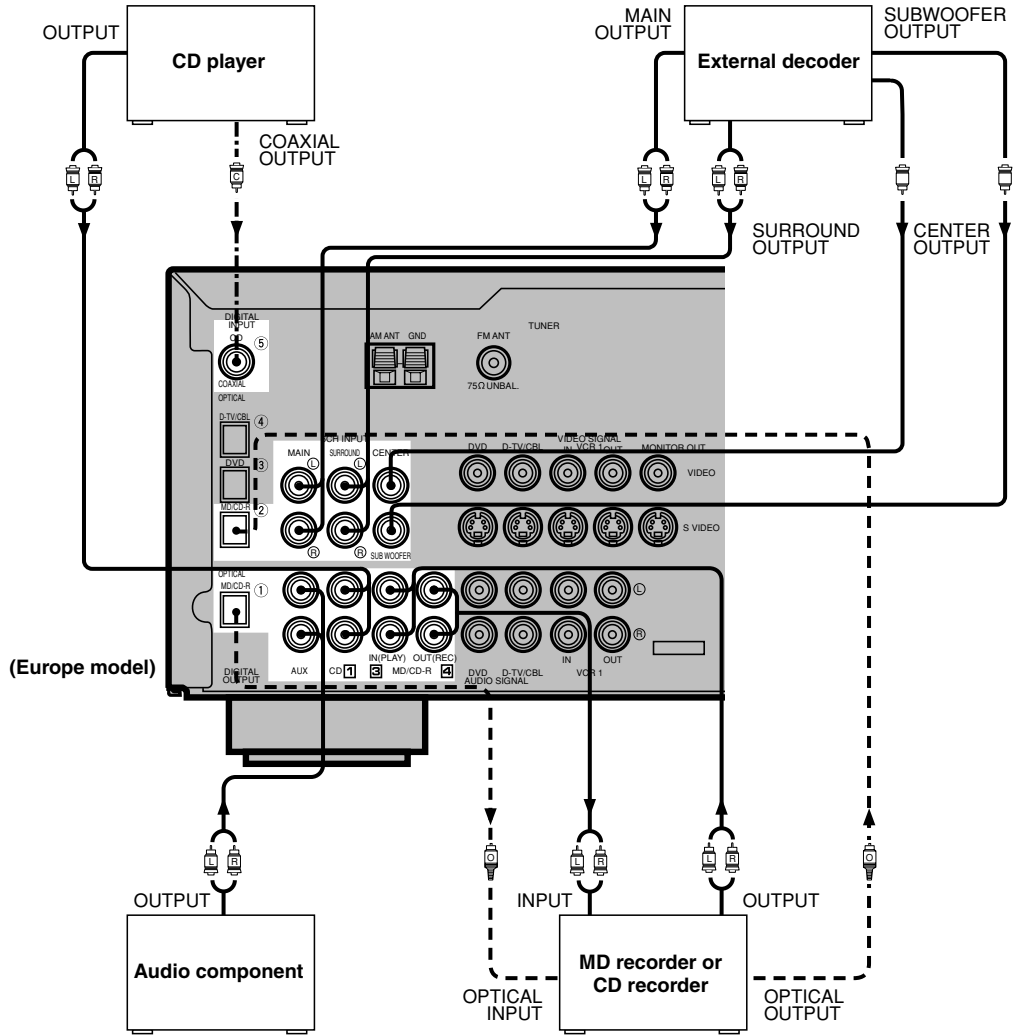

- indicates signal direction
- (L) — indicates left analog cables
- (R) — indicates right analog cables
- - - (O) - indicates optical cables
- - - (C) - indicates coaxial cables

PREPARATION

English

Connecting Video Components

■ Audio signal jacks

Be sure to connect the right channel (R), left channel (L), input (IN) and output (OUT) properly.

■ Video signal jacks

Be sure to connect the input (IN) and output (OUT) properly.

■ TV monitor with a 21-pin connector

Make a connection as shown on page 15 with a commercially available SCART-plug connector cable.

■ S VIDEO jacks

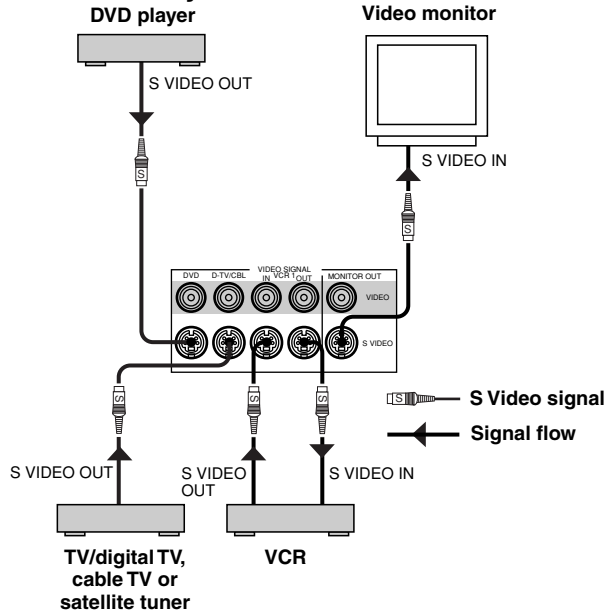

If your video component has “S” (high-resolution) video jacks, they can be connected to this unit’s S VIDEO jacks. Otherwise, connect the composite video jacks of your video component to this unit’s composite video jacks.

Notes

- Use a special S VIDEO cable (commercially available) for the S VIDEO connection.
- If video signals are input from both the S VIDEO input and composite input jacks, the signals will be directed to their respective output jacks.

■ VIDEO AUX jacks (on the front panel)

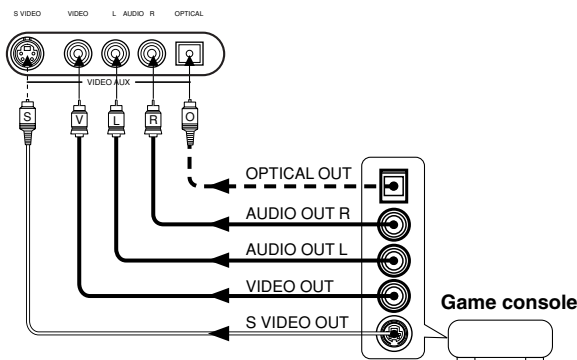

These jacks are used to connect any video input source such as a game console to this unit.

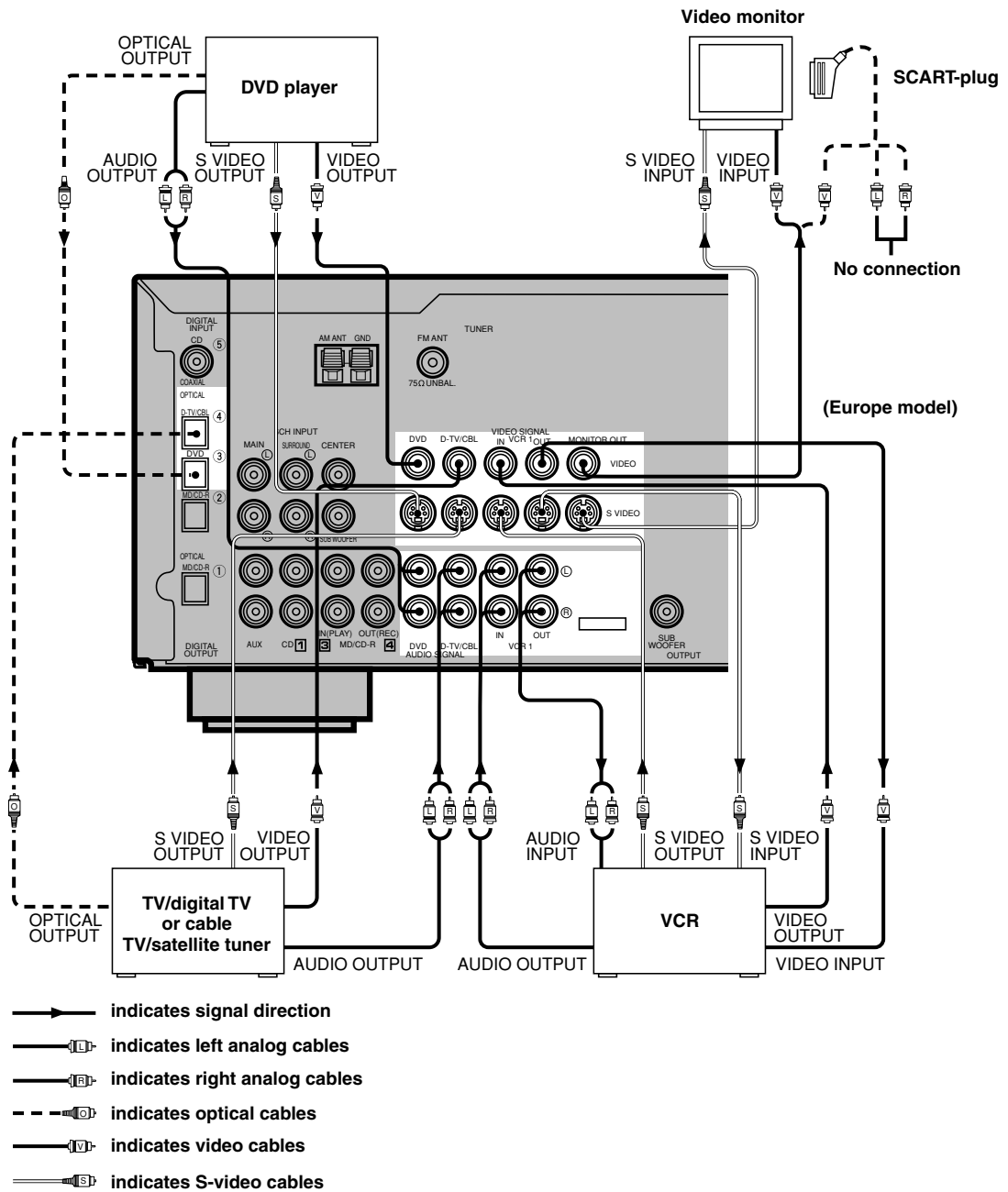

PREPARATION

When using an LD player

Connect the LD player output to the DVD jack.

If the LD player has an OPTICAL digital output jack, connect it to this unit's OPTICAL DVD jack. If it has analog jacks, connect it to the analog DVD jacks. If it has an "RF OUTPUT jack" to output a Dolby Digital RF signal (AC-3), use a commercially available RF demodulator and connect it to the OPTICAL DVD jack.

If connecting a DVD player and an LD player, connect the LD player to the digital input jack (ex. D-TV/CBL) or the analog input jack (D-TV/CBL or VCR 1). For details on connections and operations, refer to the operation instructions for the LD player.

Note that this unit's remote control can be used to operate the LD player by setting the corresponding manufacturer code for the DVD/LD mode.

English

Connecting Speakers

Be sure to connect the right channel (R), left channel (L), “+” (red) and “-” (black) properly. If the connections are faulty, no sound will be heard from the speakers, and if the polarity of the speaker connections is incorrect, the sound will be unnatural and lack bass.

CAUTION

- Use speakers with the specified impedance shown on the rear panel of this unit.
- Do not let the bare speaker wires touch each other and do not let them touch any metal part of this unit. This could damage the unit and/or speakers.

Speaker cables

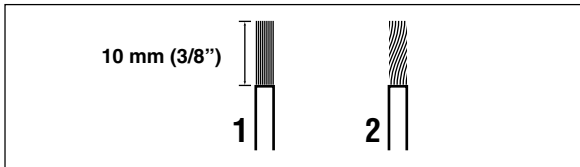

- 1 Remove approx. 10 mm (3/8") of insulation from each of the speaker cables.
- 2 Twist the exposed wires of the cable together to prevent short circuits.

Connecting to the MAIN SPEAKERS terminals

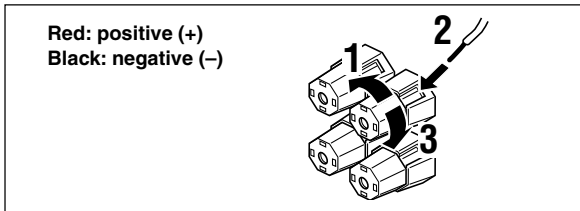

- 1 Unscrew the knob.
- 2 Insert one bare wire into the hole in the side of each terminal.
- 3 Tighten the knob to secure the wire.

Connecting to the REAR and CENTER SPEAKERS terminals

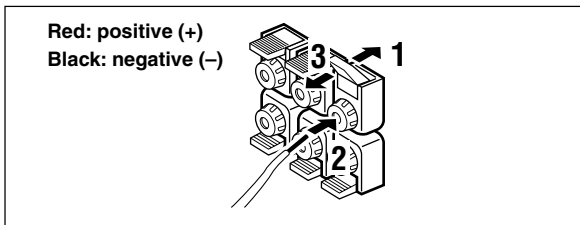

- 1 Open the tab.
- 2 Insert one bare wire into the hole of each terminal.
- 3 Return the tab to secure the wire.

Main speaker terminals

One or two speaker systems can be connected to these terminals. If you use only one speaker system, connect it to either of the SPEAKERS A or B terminals.

Rear speaker terminals

A rear speaker system can be connected to these terminals.

Center speaker terminals

A center speaker can be connected to these terminals.

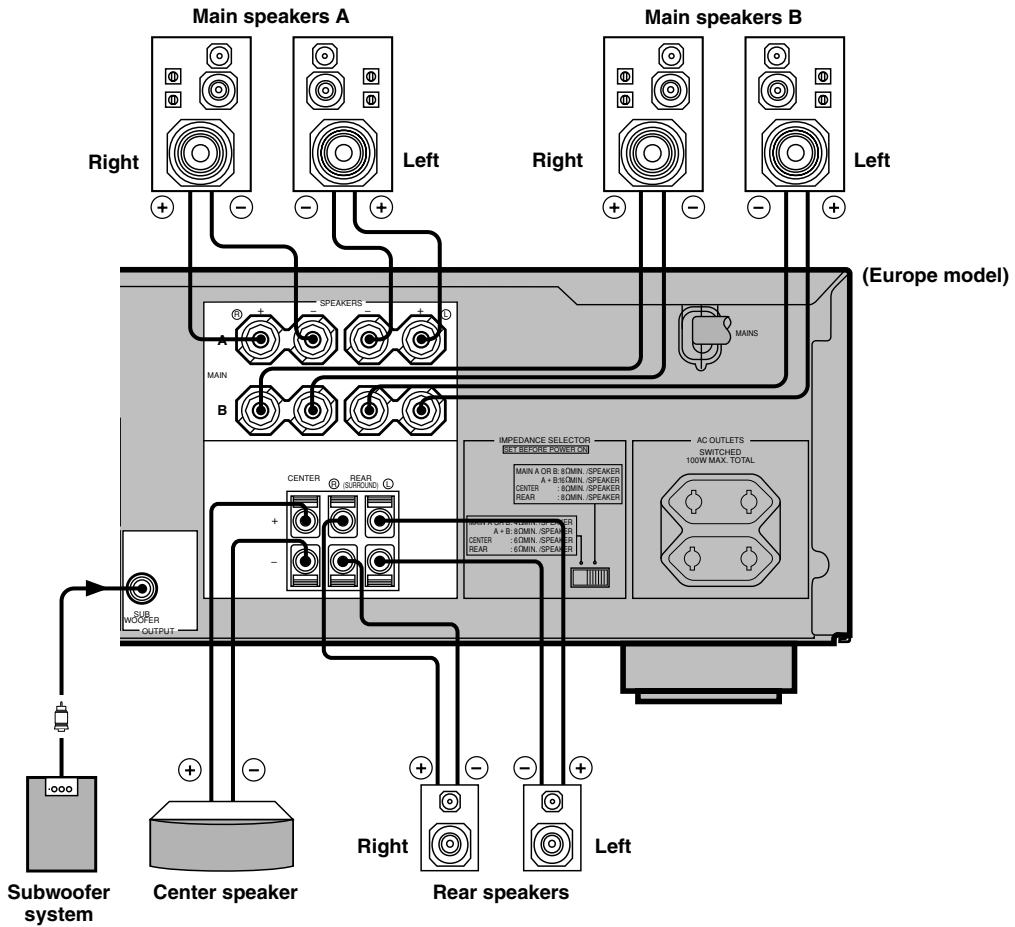

PREPARATION

■ Subwoofer connection

When using a subwoofer with built-in amplifier, including the YAMAHA Active Servo Processing Subwoofer System, connect the input jack of the subwoofer system to this jack. Low bass signals distributed from the main, center and/or rear channels are directed to this jack. (The cut-off frequency of this jack is 90 Hz.) The LFE (low-frequency effect) signals generated when Dolby Digital or DTS is decoded are also directed if they are assigned to this jack.

Notes

- Adjust the subwoofer volume according to the operation instructions for the subwoofer. (Fine adjustment is possible using this unit's output level control of the effect speakers.)
- Depending on the settings of "1 SPEAKER SET", "LFE LEVEL (5 DOLBY D. SET)" and "6 DTS SET" in the SET MENU, some signals may not be output from the SUBWOOFER jack.

English

IMPEDANCE SELECTOR Switch

WARNING

Do not change the IMPEDANCE SELECTOR switch setting while the power to this unit is on, otherwise the unit may be damaged.

If this unit fails to turn on when STANDBY/ON (or POWER) is pressed, the IMPEDANCE SELECTOR switch may not be fully slid either position. If so, slide the switch to either position fully when this unit is in the standby mode.

Select the right or left position according to the impedance of speakers in your system. Be sure to move this switch only when this unit is in the standby mode.

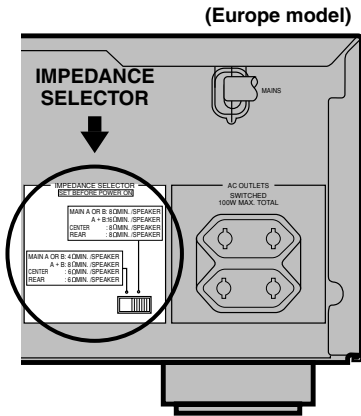

Switch position	Speaker	Impedance level
Left	Main	If you use one set of main speakers, the impedance of each speaker must be 4 Ω or higher.
		If you use two sets of main speakers, the impedance of each speaker must be 8 Ω or higher.
	Center	The impedance must be 6 Ω or higher.
	Rear	The impedance of each speaker must be 6 Ω or higher.
Right	Main	If you use one set of main speakers, the impedance of each speaker must be 8 Ω or higher.
		If you use two sets of main speakers, the impedance of each speaker must be 16 Ω or higher.
	Center	The impedance must be 8 Ω or higher.
	Rear	The impedance of each speaker must be 8 Ω or higher.

Connecting the Power Supply Cords

After completing all connections, connect the AC power cord to an AC power outlet. Disconnect the AC power cord if you will not use this unit for a long period of time.

■ AC OUTLETS (SWITCHED)

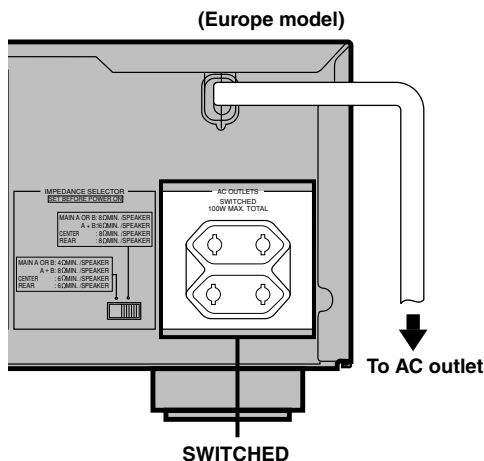

Europe model 2 OUTLETS

U.K. model 1 OUTLET

Use these outlets to connect the power cords only from your audio/video components to this unit. The power to the AC OUTLET(S) is controlled by this unit's STANDBY/ON (or POWER). These outlets will supply power to any connected component whenever this unit is turned on. The maximum power (total power consumption of components) that can be connected to the AC OUTLET(S) is 100 W.



ADJUSTING THE SPEAKER BALANCE

This procedure lets you adjust the sound output level balance between the main, center and rear speakers by using the built-in test tone generator. When this adjustment is performed, the sound output level heard at the listening position will be the same from each speaker. This is important for the best performance of the digital sound field processor, the Dolby Pro Logic decoder, Dolby Digital decoder and DTS decoder.

Note

- Since this unit cannot enter the test mode while headphones are connected to this unit, be sure to unplug the headphones from the PHONES jack when using the test tone.

Before You Start Adjusting

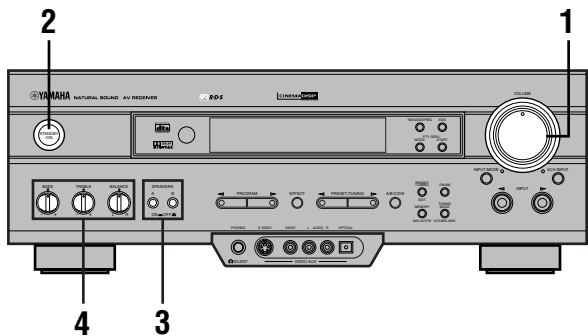

1 Set the volume at the minimum level.

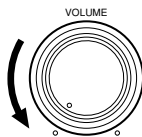

2 Turn the power on.



3 Press **SPEAKERS A** or **B** to select the main speakers to be used.

If you use two main speaker systems, press both A and B.

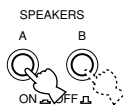

4 Set **BASS**, **TREBLE** and **BALANCE** to the center position.

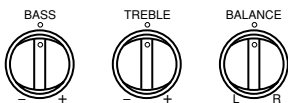

Using the Test Tone

The adjustment of each speaker sound output level should be performed at your listening position with the remote control.

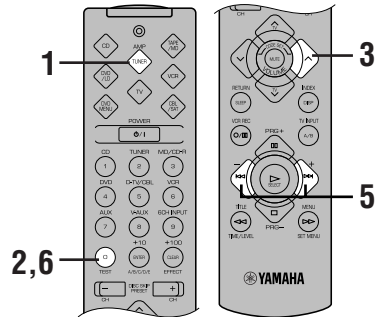

1 Press **AMP(TUNER)** on the component selector.



2 Press **TEST**.

“TEST LEFT” appears on the display.



TEST LEFT

3 Turn up the volume.

You will hear a test tone (like pink noise) from each speaker for about two seconds in following order: left main speaker, center speaker, right main speaker, right rear speaker and left rear speaker. The display changes as shown below.

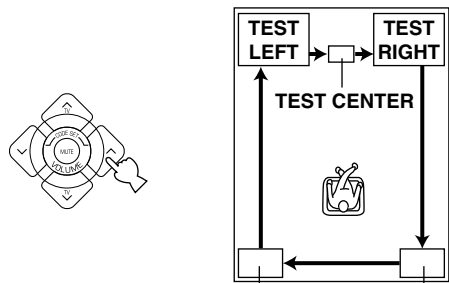

Notes

- If the test tone cannot be heard, turn down the volume, set the unit in the standby mode and check the speaker connections.
- If the test tone cannot be heard from the center speaker, check the setting of “CENTER SP” in the SET MENU.

- 4** Adjust **BALANCE** on the front panel so that the sound output level of the right main speaker and the left main speaker is the same.

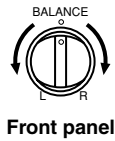

- 5** Press **-/+** repeatedly to adjust the output level of the speaker currently outputting the test tone so that it becomes almost the same as that of the main speakers.

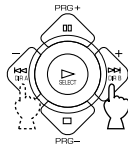

While adjusting, the test tone is heard from the selected speaker.

- 6** When the adjustment is complete, press **TEST**.

The test tone stops.



Notes

- If “CENTER SP” in the SET MENU is set to the NON position, the sound output level of the center speaker cannot be adjusted in step 5. The center channel sound is automatically output from the right and left main speakers.
- For details on adjusting the subwoofer speaker, refer to “DELAY TIME AND SPEAKER OUTPUT LEVELS” on page 40.
- After adjusting with the test tone, it is possible to adjust the speaker level to taste while listening to the playback of an actual source. Refer to “DELAY TIME AND SPEAKER OUTPUT LEVELS” on page 40.



- Once you have completed the adjustments, you can only adjust the overall volume level of your audio system by using **VOLUME** (or **VOLUME** (∧/∨)).
- If there is insufficient sound output from the center and rear speakers, you may decrease the main speaker output level by setting “MAIN LVL” in the SET MENU to “-10 dB”.



PLAYING A SOURCE

When using the remote control, press AMP(TUNER) on the component selector.

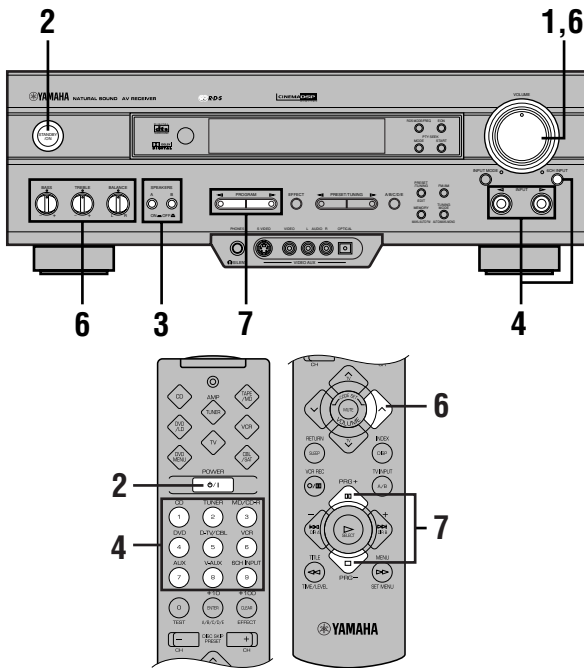

4 Select the desired input source with INPUT </> (or the input selector buttons). (Turn on the video monitor for video sources.)

The name of the selected input source appears on the display.

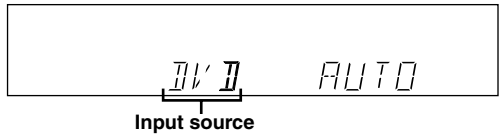
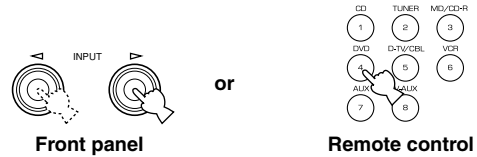

To select a source connected to the 6CH INPUT jacks

Press 6CH INPUT so that "6CH INPUT" appears on the display.

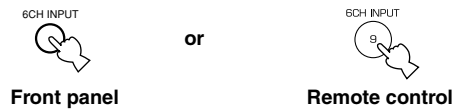

6CH INPUT

1 Set the volume at the minimum level.

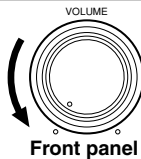

2 Turn the power on.



Front panel

or



Remote control

3 Press SPEAKERS A or B to select the main speakers to be used.

If you use two main speaker systems, press both A and B.

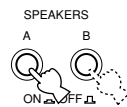

Front panel

Notes

- An audio source can not be played if "6CH INPUT" appears. Press 6CH INPUT to turn off "6CH INPUT".
- If you select and play a video source when "6CH INPUT" appears, the playback result will be a video image from the video source and the sound from the audio source selected by using "6CH INPUT".



- The current input mode is also shown. Refer to "Input Modes and Indications" on page 23 for details.

5 Play the source.

Refer to the instructions for the source component (and “TUNING” for details).

Note

- When controlling an audio/video component (MD recorder, CD player, DVD player, tape deck, etc.) with the remote control, press one of the component selector buttons, (TAPE/MD, CD, DVD/LD, etc.), which corresponds to the component you want to control. Refer to “PRESET REMOTE CONTROL”.

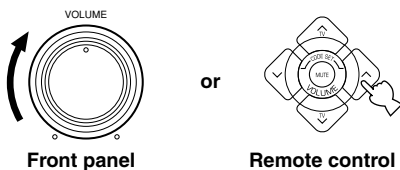
6 Adjust the volume to the desired output level.

If desired, adjust BASS, TREBLE, BALANCE, etc. These controls are only effective for the sound from the main speakers.

- BASS controls the low-frequency response.
- TREBLE controls the high-frequency response.
- BALANCE adjusts the balance of the output volume from the right and left main speakers.

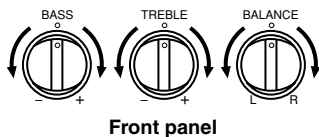
**7 Use the digital sound field processor.**

Refer to “Selecting a DSP Program”.

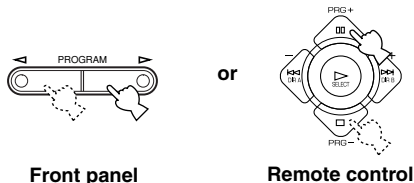
**To mute the sound**

Use this when you want to temporarily mute audio output.

Press MUTE on the remote control.

To restore the audio output to the previous volume level, press MUTE again.

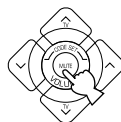
**Note**

- During muting, “MUTE ON” appears on the display.

When you have finished using this unit

Press STANDBY/ON (or POWER) to set this unit in the standby mode.

Notes on the digital signal

The digital input jacks of this unit can also handle 96-kHz sampling digital signals. (To utilize this, use a source that supports 96-kHz sampling digital signals and set the player for digital output. Refer to the operation instructions for the player.) Note the following when a 96-kHz sampling digital signal is input to this unit:

- The following indication will appear on the display.

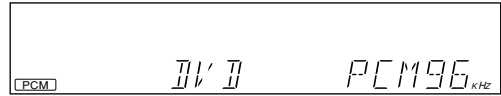

- DSP programs cannot be selected. Sound will be output as normal 2-channel stereo sound from only the left and right main speakers.

Note

- If “MAIN SP” in the SET MENU is set to SMALL and “BASS OUT” is set to SWFR or “BASS OUT” is set to BOTH, the sound is also output from the subwoofer.
- Adjustment of the speaker output level described on page 40 cannot be made (except the level of the subwoofer).

BGV (background video) function

The BGV function allows you to combine a video image from a video source with a sound from an audio source. (For example, you can listen to classical music while you are watching a video.) This function can only be controlled with the remote control.

Play a video source, and then select an audio source with the input selector buttons on the remote control. The BGV function does not work if you select the audio source with INPUT ◀/▶ on the front panel.

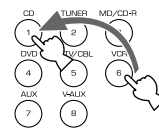

Input Modes and Indications

When using the remote control, press AMP(TUNER) on the component selector.

This unit comes with various input jacks. If your component is connected to more than one type of input jack, you can set the priority of the input signal.

Press INPUT MODE (or the input selector button that you have pressed to select the input source on the remote control) repeatedly until the desired input mode is shown on the display.

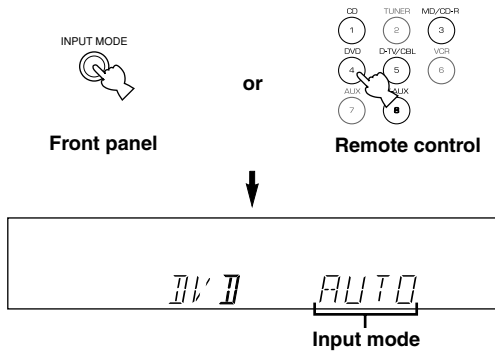

- AUTO:** In this mode, the input signal is automatically selected in the following order:
- 1) Dolby Digital or DTS signal
 - 2) Digital (PCM) signal
 - 3) Analog signal
- DTS:** In this mode, only the digital input signal encoded with DTS is selected even if another signal is input at the same time.
- ANALOG (ANLNG):** In this mode, only the analog input signal is selected even if a digital signal is input at the same time.

Notes

- If digital signals are input from both the COAXIAL and OPTICAL jacks, the digital signal from the COAXIAL jack is selected.
- When AUTO is selected, this unit automatically determines the type of signal. If this unit detects a Dolby Digital or DTS signal, the decoder automatically switches to the appropriate setting and reproduces 5.1 channel source.
- The sound output may be interrupted for some LD players and DVD players in the following situation:
When the input mode has been set to AUTO and a search is performed while playing the source encoded with a Dolby Digital or DTS signal, the sound may delay for a moment when playback is resumed.
- Depending on the LD player, playback may not be made when playing an LD that is not digitally recorded with the input mode set to AUTO. If this happens, set the input mode to ANALOG.

Notes on playing a source encoded with a DTS signal

- If the digital output data of the player has been processed in any way, you may not be able to perform DTS decoding even if you make a digital connection between this unit and the player.
- If you play a source encoded with a DTS signal and set the input mode to ANALOG, this unit reproduces the noise of an unprocessed DTS signal. When you want to play a DTS source, be sure to connect the source to a digital input jack and set the input mode to AUTO or DTS.
- If you switch the input mode to ANALOG while playing a source encoded with a DTS signal, this unit reproduces no sound.
- The following phenomena may occur if the input mode is set to AUTO when playing back a source encoded with DTS:
 - If you continue to play a source encoded with a DTS signal, this unit automatically switches to the “DTS-decoding” mode to prevent noise from being generated during subsequent operation. (The “**dts**” indicator lights up on the display.) The “**dts**” indicator may flash immediately after playback of a source encoded with a DTS signal has finished. Only a source encoded with a DTS signal can be played back while this indicator is flashing. (The indicator will flash for less than a minute.) If you want to play a normal PCM source soon, set the input mode back to AUTO.
 - The “**dts**” indicator may flash when a search or skip operation is performed. If this status continues for a certain length of time, the unit will automatically switch from the “DTS-decoding” mode to PCM digital signal input mode and the “**dts**” indicator will go out.

Selecting a DSP Program

You can enhance your listening experience by selecting a DSP program. Refer to “SOUND FIELD PROGRAM” for details about each program.



- Make sure that the sound effect is turned on (see page 25).

■ On the remote control

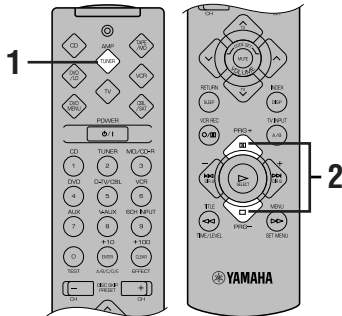

- 1** Press AMP(TUNER) on the component selector.



- 2** Press PRG+ or PRG- repeatedly to select the desired program.

The name of the selected program appears for a moment and the selected DSP program indicator lights up on the display.

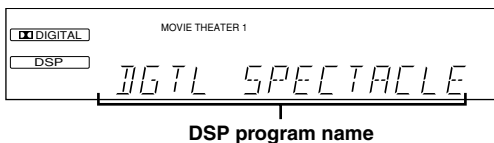
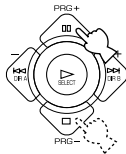

DSP program name

■ On the front panel

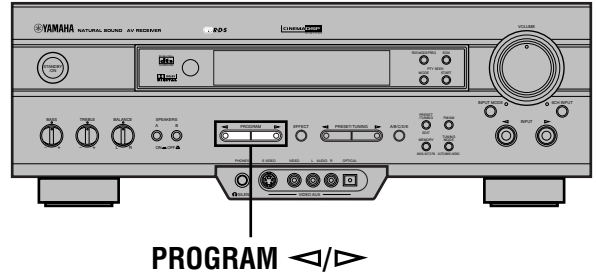

- 1** Press PROGRAM ◀ or ▶ repeatedly to select the desired program.

The name of the selected program appears for a moment and the selected DSP program indicator lights up on the display.

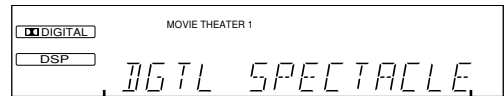
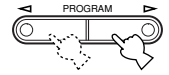

DSP program name



- If desired, adjust the delay time and the sound output level of each speaker. (Refer to “DELAY TIME AND SPEAKER OUTPUT LEVELS” on page 40 for details.)

Notes

- Choose a DSP program based on your listening preference, and not on the name of the program. The acoustics of your listening room affect the DSP program. Minimize the sound reflections in your room to maximize the effect created by the program.
- When you select an input source, this unit automatically selects the last DSP program used with that source.
- When you set this unit in the standby mode, the current source and DSP program are memorized and are automatically selected when you turn on the power again.
- If a Dolby Digital or DTS signal is input when the input mode is set to AUTO, the DSP program automatically switches to the appropriate decoding program.
- When a monaural source is being played with PRO LOGIC/ NORMAL or PRO LOGIC/ENHANCED, no sound will be heard from the main speakers and the rear speakers. Sound can only be heard from the center speaker. However, if “CENTER SP” in the SET MENU is set to NON, the center channel sound is output from the main speakers.
- When a source connected to the 6CH INPUT jack of this unit is selected, the digital sound field processor cannot be used.
- When 96-kHz sampling digital signals are input to this unit, the DSP program cannot be selected. In this case, the sound is reproduced as normal 2-channel stereo.

■ Virtual CINEMA DSP and SILENT CINEMA

Virtual CINEMA DSP

Virtual CINEMA DSP allows you to enjoy the sound field effects of the DSP program without rear speakers. Using YAMAHA original technology, natural surround reproduction is possible through the generation of a virtual speaker.

The sound field processing is changed to the Virtual CINEMA DSP mode by setting "REAR LR SP" on the SET MENU to NON. Virtual CINEMA DSP is performed by using the main speakers.

Note

- This unit is not set in the Virtual CINEMA DSP mode even if "REAR LR SP" is set to NON in the following cases:
 - when the 5CH STEREO, PRO LOGIC/NORMAL, DOLBY DIGITAL/NORMAL or DTS/NORMAL program is selected;
 - when the sound effect is turned off;
 - when 6CH INPUT is selected as the input source;
 - when 96-kHz sampling digital signals are input to this unit;
 - when the Dolby Digital KARAOKE source is played;
 - when using the test tone; or
 - when connecting the headphones (you will hear SILENT CINEMA).

SILENT CINEMA

SILENT CINEMA allows you to enjoy the realistic feel of the DSP program while using headphones. This feature delivers powerful surround reproduction just as if listening through the speakers.

You can listen to SILENT CINEMA by connecting your headphones to the PHONES jack while the effect speakers are on.

Canceling the Sound Effect (turning off the effect speakers)

Press EFFECT to cancel the sound effect and monitor only the main sound.

Press EFFECT again to turn the sound effect back on.

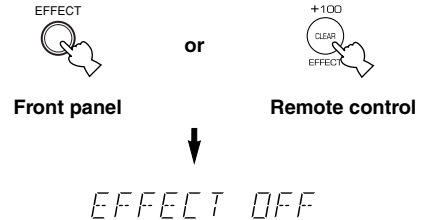

Notes

- If the sound effect is canceled when Dolby Digital or DTS is decoding, the sounds of the center and rear channels are mixed and output from the main speakers.
- If you turn off the sound effect when Dolby Digital or DTS is decoding, it may happen that the sound is output faintly or not output normally, depending on the source. In that case, turn back on the sound effect.

Connecting the Antennas

Both AM and FM indoor antennas are included with this unit. In general, these antennas should provide sufficient signal strength.

Connect each antenna correctly to the designated terminals.

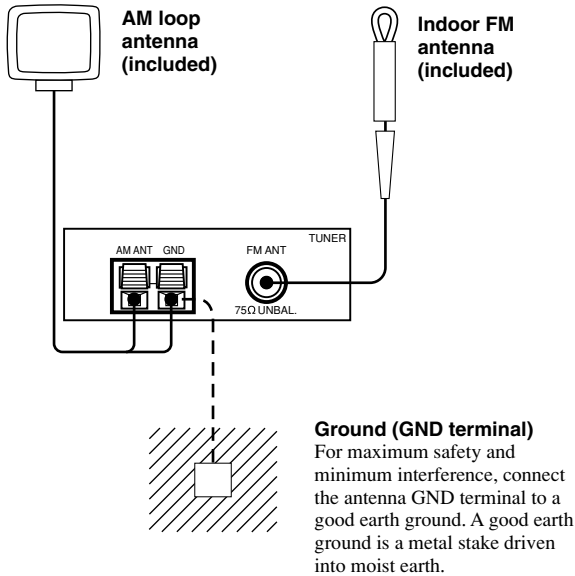

Connecting the indoor FM antenna

Connect the included indoor FM antenna to the FM ANT 75Ω UNBAL. terminal.

Note

- Do not connect an outdoor FM antenna and the indoor FM antenna at the same time.

Connecting the AM loop antenna

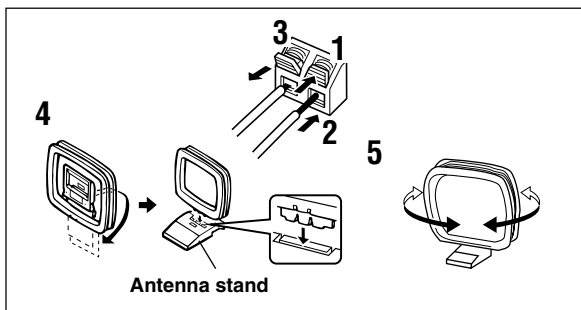

- Press and hold the tab to unlock the terminal hole.
- Insert the AM loop antenna lead wires into the AM ANT and GND terminals.

3 Release the tab to lock the lead wires.

Lightly pull the lead wires to confirm a good connection.

4 Attach the loop antenna to the antenna stand.

5 Orient the AM loop antenna so that the best reception is obtained.



- The AM loop antenna can be removed from the stand and attached to a wall, etc.

Notes

- The AM loop antenna should be placed away from this unit.
- The AM loop antenna should always be connected, even if an outdoor AM antenna is connected to this unit.

A properly installed outdoor antenna provides clearer reception than an indoor one. If you experience poor reception quality, an outdoor antenna may improve the quality. Consult the nearest authorized YAMAHA dealer or service center about the outdoor antennas.

Connecting a coaxial cable to the included 75-ohm/300-ohm antenna adapter (U.K. model only)

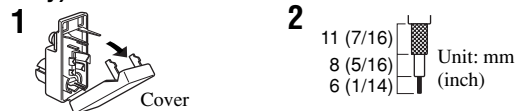

Open the cover of the included 75-ohm/300-ohm antenna adapter.

Cut the external sleeve of the 75-ohm coaxial cable and prepare it for connection.

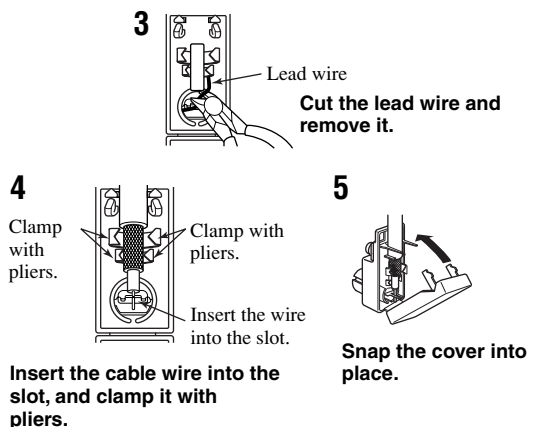

Insert the cable wire into the slot, and clamp it with pliers.

Automatic Tuning

Automatic tuning is effective when station signals are strong and there is no interference.

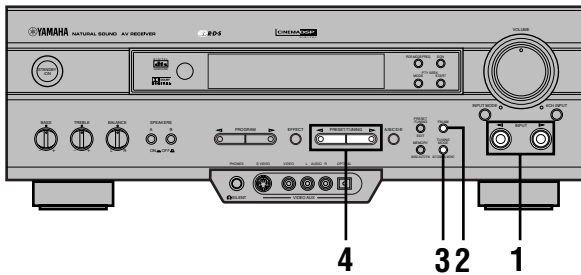

- 1 Use INPUT $\triangleleft/\triangleright$ to select TUNER as the input source.

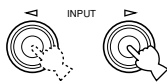

- 2 Press FM/AM to select the reception band (FM or AM).

“FM” or “AM” appears on the display.

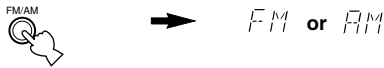

- 3 Press TUNING MODE (AUTO/MAN'L MONO) so that the “AUTO” indicator lights up on the display.



If “>” appears on the display next to the band indication, press PRESET/TUNING (EDIT) to turn it off.

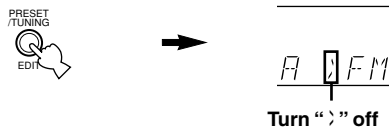

- 4 Press PRESET/TUNING \triangleleft once to tune in to a lower frequency and \triangleright once to tune in to a higher frequency.

Press the button again if the tuning search does not stop at the desired station.



- Use the manual tuning method if the tuning search does not stop at the desired station (because the signal from the station is weak).
- When tuned in to a station, the “TUNED” indicator lights up and the frequency of the received station is shown on the display. If an RDS station that offers the PS data service is being received, the station name is shown instead of the frequency on the display.

Manual Tuning

If the signal from the station you want to select is weak, you must tune in to it manually.

- 1 Use INPUT $\triangleleft/\triangleright$ to select TUNER as input source.

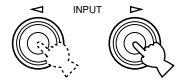

- 2 Press FM/AM to select the reception band (FM or AM).

“FM” or “AM” appears on the display.



- 3 Press TUNING MODE (AUTO/MAN'L MONO) so that the “AUTO” indicator goes off.



If “>” appears on the display next to the band indication, press PRESET/TUNING (EDIT) to turn it off.

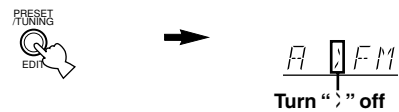

- 4 Press PRESET/TUNING \triangleleft or \triangleright to tune in to the desired station.

To continue the tuning search, hold down the button.



Note

- If you tune in manually to an FM station, it will be automatically received in monaural mode to increase the signal quality.

Automatic Preset Tuning (for RDS stations only)

You can make use of the automatic preset tuning function for RDS stations only. This function enables the unit to automatically tune in with strong signals and to sequentially store up to 40 RDS stations (5 groups x 8 stations).

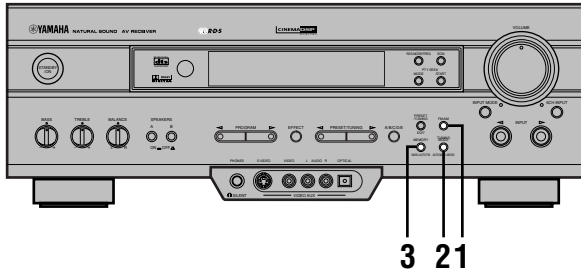

1 Press FM/AM to select the FM band.

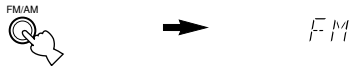

2 Press TUNING MODE (AUTO/MAN'L MONO) so that the "AUTO" indicator lights up on the display.



3 Hold down MEMORY (MAN'L/AUTO FM) for about 3 seconds.

The preset number, the "MEMORY" and "AUTO" indicators flash. After about 5 seconds, automatic preset tuning begins from the frequency currently displayed toward the higher frequencies.

Received stations are sequentially stored as A1, A2 ... A8. If more than 8 stations have been tuned, they are stored as preset station numbers in other groups (B, C, D and E) in that order.

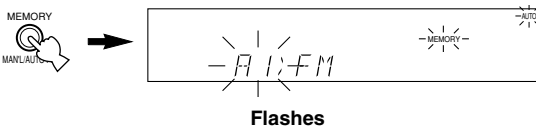

Automatic preset tuning options

You can select the preset number from which the unit will store RDS stations and/or begin tuning toward lower frequencies. Before automatic preset tuning begins (after pressing MEMORY in step 3),

1. Press A/B/C/D/E and PRESET/TUNING < or > to select the preset number with which the first station will be stored. The automatic preset tuning will stop when stations have all been stored up to E8.
2. Press PRESET/TUNING (EDIT) to turn ">" off and then press PRESET/TUNING < to begin tuning toward lower frequencies.

When automatic preset tuning is completed

The display shows the frequency of the last preset station. Check the contents and the number of preset stations by following the procedure in the section "To Recall a Preset Station" on page 29.

Notes

- A new setting can be stored in place of the former one.
- The reception mode is stored along with the station frequency.
- You can manually replace a preset station with another FM or AM station by simply using the manual preset tuning method.
- Automatic preset tuning will be performed for all RDS network stations until all have been stored up to E8. Even if the number of received stations is not enough to be stored up to E8, automatic preset tuning is automatically ended after searching for all stations.
- Only RDS stations with sufficient signal strength are stored by automatic preset tuning. If the station you want to store is weak in signal strength, tune in to it manually in monaural mode and store it by using the manual preset tuning method. (There may be a case that this unit cannot receive a station which could be received by using the automatic tuning method. This is because this unit receives a large amount of PI (Program Identification) data along with the station.)

Memory back-up

The memory back-up circuit prevents the stored data from being lost when this unit is set in the standby mode. If, however, the power cord is disconnected from the AC power outlet or the power is cut for more than one week, the memory will be erased. If so, store the stations again by using preset tuning methods.

Manual Preset Tuning

You can also store up to 40 stations (5 groups x 8 stations) manually.

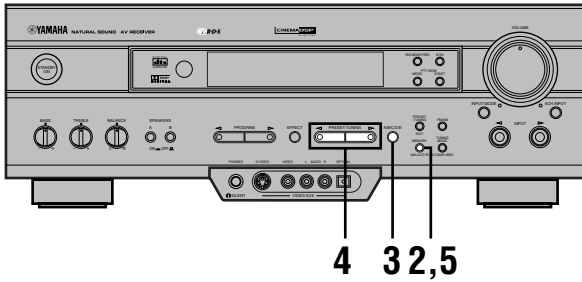

1 Tune in to the desired station.
Refer to "Automatic/Manual Tuning" for the tuning procedure.

2 Press MEMORY (MAN'L/AUTO FM).
The "MEMORY" indicator flashes for about 5 seconds.

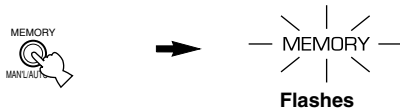

3 Press A/B/C/D/E repeatedly to select the desired group (A to E) of preset stations before the "MEMORY" indicator goes off.
Make sure that ">" appears on the display. The selected group appears on the display.



4 Press PRESET/TUNING < or > to select a preset station number (1 to 8) with which you want to store the station before the "MEMORY" indicator goes off.

Press < to select a lower preset station number and > to select a higher preset station number.

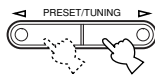

5 Press MEMORY (MAN'L/AUTO FM) before the "MEMORY" indicator goes off.

The displayed station has been stored as the preset group and number you have selected, and the reception band and frequency appear and the "TUNED" indicator lights up on the display.

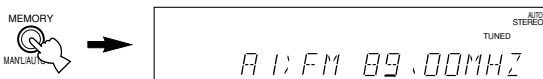

6 Repeat steps 1 to 5 to store other stations.

Notes

- A new setting can be stored in place of the former one.
- The reception mode is stored along with the station frequency.

To Recall a Preset Station

You can recall any desired station simply by selecting the preset station number with which it was stored.

You can also recall a preset station with the remote control. Press AMP(TUNER) on the component selector and press TUNER on the input selector.

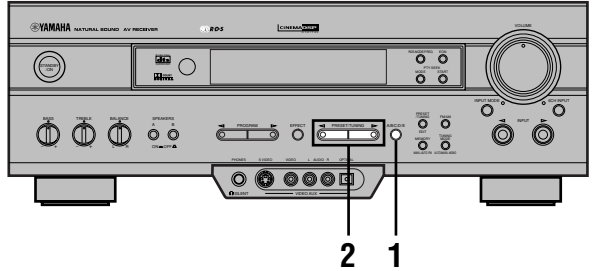

1 Press A/B/C/D/E to select the required group of preset stations.

Make sure that ">" appears on the display.

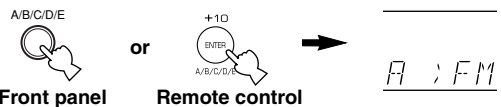

2 Press PRESET/TUNING < or > (or PRESET +/-) to select a preset station number (1 to 8).

The preset group and number appear on the display along with the reception band, frequency, and the "TUNED" indicator lights up.

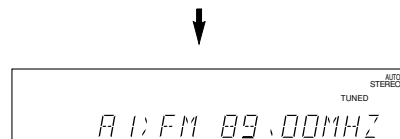
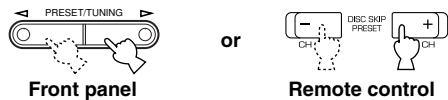

Exchanging Preset Stations

You can exchange the assignment of two preset stations with each other.

Example: Exchange preset station “E1” with “A5”

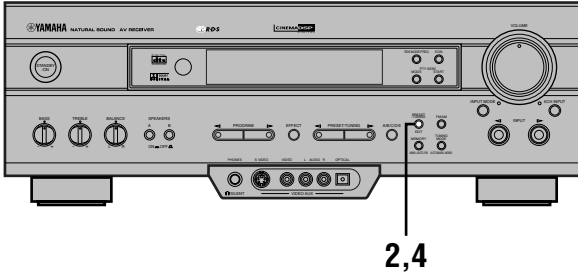

1 Recall preset station “E1”.

Refer to the procedure in the section “To Recall a Preset Station” on page 29.

2 Hold down (PRESET/TUNING) EDIT for about 3 second.

“E1” and the “MEMORY” indicator flash.

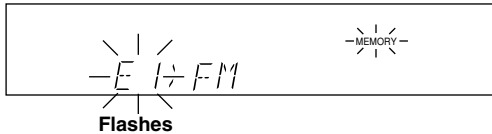

3 Recall preset station “A5” by using the buttons on the front panel.

“A5” and the “MEMORY” indicator flash.

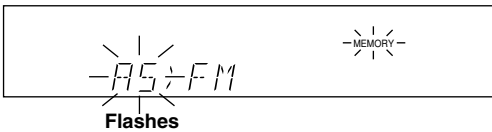

4 Press (PRESET/TUNING) EDIT again.

The display shows the exchange of stations has been completed.

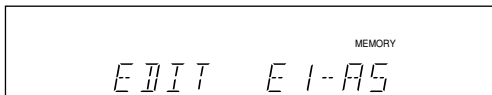



RECEIVING RDS STATIONS

Radio Data System (RDS) is a data transmission system by FM stations in many countries. Stations using this system transmit an inaudible stream of data in addition to the normal radio signal.

RDS data contains various information such as PI (Program Identification), PS (Program Service name), PTY (Program Type), RT (Radio Text), CT (Clock Time), EON (Enhanced Other Networks), etc. The RDS function is carried out among the network stations.

Description of RDS Data

This unit can receive PI, PS, PTY, RT, CT, and EON data when receiving RDS broadcasting stations.

■ PS (Program Service name) mode:

The name of the RDS station being received is displayed.

■ PTY (Program Type) mode:

The program type on the RDS station being received is displayed. There are 15 program types to classify RDS stations. You can make this unit search for a station which is broadcasting a program of the desired type. Refer to "PTY SEEK Function" for details.

■ RT (Radio Text) mode:

Information about the program (such as the title of the song, name of the singer, etc.) on the RDS station being received is displayed by a maximum of 64 alphanumeric characters, including the umlaut symbol. If other characters are used for RT data, they are displayed with under-bars.

■ CT (Clock Time) mode:

The current time is displayed and updated every minute. If the data are accidentally cut off, "CT WAIT" may appear.

■ EON (Enhanced Other Networks):

Refer to "EON Function" on page 33.

Changing the RDS Mode

The four modes are available in this unit for displaying RDS data. When an RDS station is being received, PS, PTY, RT and/or CT that correspond to the RDS data services offered by the station light up on the display. Press RDS MODE/FREQ repeatedly to change the display mode among the RDS data offered by the transmitting station in the order shown below. Illumination of the red indicator next to the RDS mode indicator shows that the corresponding RDS mode is now selected.

Notes

- When an RDS station is being received, do not press RDS MODE/FREQ until one or more RDS mode indicators light up on the display. If you press the button before the indicators light up on the display, the mode cannot be changed. This is because the unit has not yet received all of the RDS data on the station.
- RDS data not offered by the station cannot be selected.
- The RDS data service cannot be utilized by this unit if the received signal is not strong enough. In particular, the RT mode requires a large amount of data to be received, so it is possible that the RT mode may not be displayed even if other RDS modes (PS, PTY, etc.) are displayed.
- RDS data cannot sometimes be received under poor reception conditions. If so, press TUNING MODE so that the "AUTO" indicator goes off from the display. Although the reception mode is changed to monaural by this operation, when you change the display to RDS mode, RDS data may be displayed.
- If the signal strength is weakened by external interference during the reception of an RDS station, the RDS data service may be cut off suddenly and "...WAIT" will appear on the display.

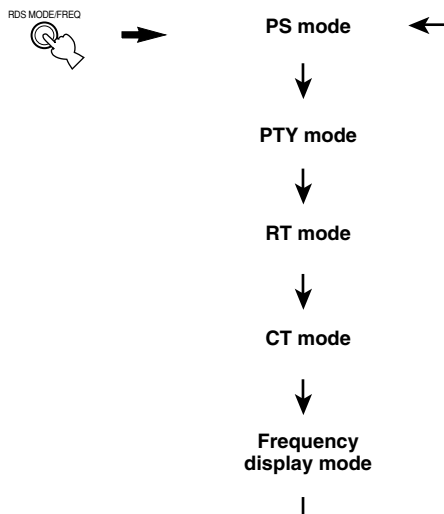

PTY SEEK Function

If you select the desired program type, the unit automatically searches all preset RDS stations that are broadcasting a program of the required type.

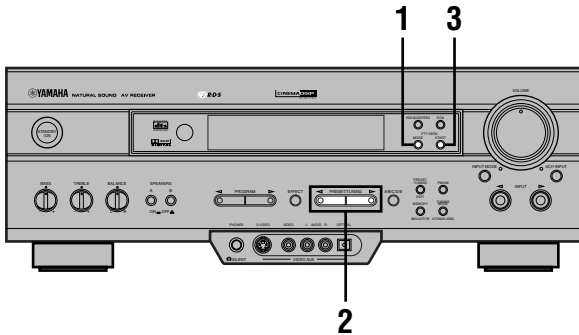

1 Press PTY SEEK MODE to set the unit in the PTY SEEK mode.

The program type of the station being received or “NEWS” flashes on the display.



2 Press PRESET/TUNING ◀ or ▶ to select the desired program type.

The selected program type flashes on the display.

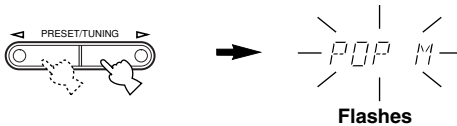

3 Press PTY SEEK START to begin searching all preset RDS stations.

The selected program type flashes and the “PTY HOLD” indicator lights up on the display while searching for stations.

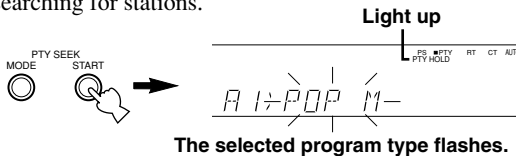

The selected program type flashes.

- If a station that is broadcasting a program of the required type is found, the unit stops at that station.
- If the called station is not the desired one, press PTY SEEK START again. The unit begins searching for another station that is broadcasting a program of the same type.

■ To cancel this function

Press PTY SEEK MODE twice.

■ Program types in the PTY mode

There are 15 program types to classify RDS stations.

NEWS	News
AFFAIRS	Current affairs
INFO	General information
SPORT	Sports
EDUCATE	Education
DRAMA	Drama
CULTURE	Culture
SCIENCE	Science
VARIED	Light entertainment
POP M	Pops
ROCK M	Rock
M.O.R. M	Middle-of-the-road music (easy-listening)
LIGHT M	Light classics
CLASSICS	Serious classics
OTHER M	Other music

EON Function

This function uses the EON data service on the RDS station network. If you simply select the desired program type (NEWS, INFO, AFFAIRS or SPORT), the unit automatically searches for all preset RDS stations that are scheduled to broadcast a program of the required type and switches from the station being currently received to the new station when the broadcasts starts.

Note

- This function can only be used when an RDS station that offers the EON data service is being received. When such a station is being received, the "EON" indicator lights up on the display.

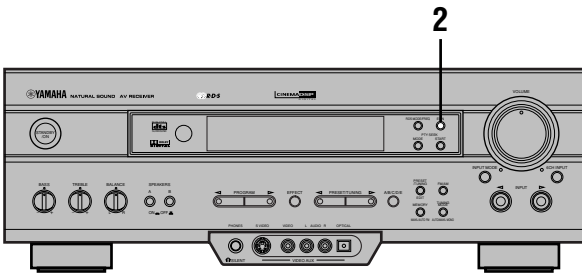

1 Make sure that the "EON" indicator lights up on the display.

If the "EON" indicator does not light up, tune in to another RDS station so that the "EON" indicator lights up.

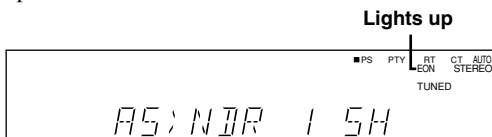

2 Press EON repeatedly to select the desired program type (NEWS, INFO, AFFAIRS or SPORT).

The selected program type name indicator lights up on the display.



Lights up

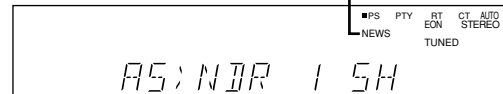

- If a preset RDS station of the selected program type starts broadcasting, the unit will automatically switch from the program being currently received to that program. The program type name indicator flashes.

Flashes

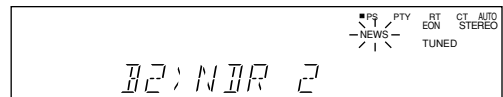

- When broadcasting of the required program ends, the previously received station (or another program on the same station) is recalled.



■ To cancel this function

Press EON repeatedly until no program type name lights up on the display.

RECORDING A SOURCE

Recording adjustments and other operations are performed from the recording component. Refer to the instructions for these components.

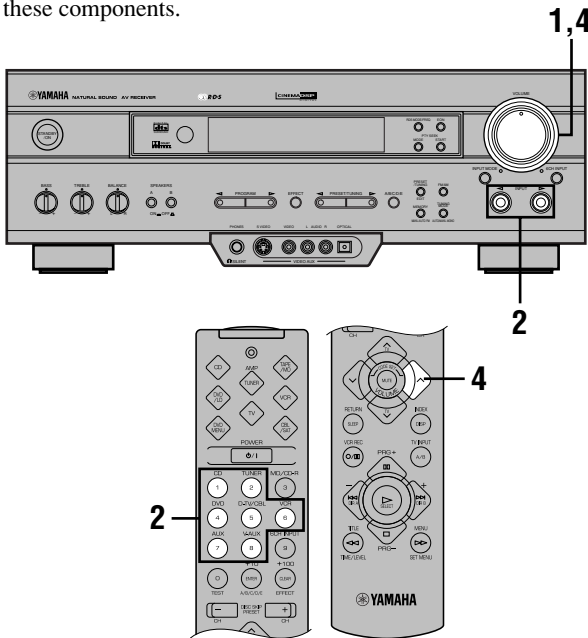

Notes

- Do a test recording before you start an actual recording.
- When this unit is set in the standby mode, you cannot record between other components connected to this unit.
- The DSP program and the setting of VOLUME, BASS, TREBLE and BALANCE have no effect on the material being recorded.
- A source connected to the 6CH INPUT jacks of this unit cannot be recorded.
- Composite video and S video signals pass independently through this unit's video circuits. Therefore, when recording or dubbing video signals, if your video source component is connected to provide only an S video (or only a composite video) signal, you can record only an S video (or only a composite video) signal by your VCR.
- A given input source is not output on the same REC OUT channel. (For example, the signal input from VCR 1 IN is not output on VCR 1 OUT.)
- Check the copyright laws in your country to record from records, CDs, radio, etc. Recording of copyrighted material may infringe copyright laws.

If you play back a video source that uses scrambled or encoded signals to prevent it from being dubbed, the picture itself may be disturbed due to those signals.

- 1** Set the volume at the minimum level.

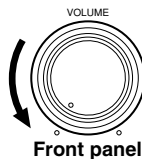

- 2** Select the source you want to record.

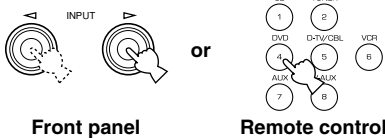

Special considerations when recording DTS software

The DTS signal is a digital bitstream. Attempting to digitally record the DTS bitstream will result in noise being recorded. Therefore, if you want to use this unit to record sources that have DTS signals recorded on them, the following considerations and adjustments need to be made.

For DVDs and CDs encoded with DTS

Only 2-channel analog audio signals may be recorded. Set the DVD player (or CD player) as described in the player's operation instructions so that the audio signals are output from the player's analog outputs.

- 3** Begin recording by the recording component connected to this unit.

- 4** Play the source and then turn up the volume to confirm the input source.

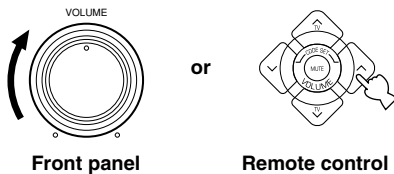



SET MENU

The SET MENU consists of 9 items including the speaker mode setting. Use the SET MENU to enjoy the optimum audio/video playback for your system.



- You can adjust the items on the SET MENU while playing a source.

1 SPEAKER SET

CENTER SP

MAIN SP

REAR LR SP

BASS OUT

MAIN LVL

2 HP TONE CTRL

3 I/O ASSIGN

4 INPUT MODE

5 DOLBY D. SET

LFE LEVEL

D-RANGE

6 DTS SET

7 SP DLY TIME

8 DISPLAY SET

9 MEM. GUARD

Adjusting the Items on the SET MENU

Adjustment should be made with the remote control.

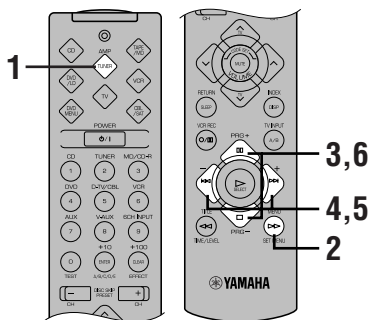

Note

- Some items require extra steps to change to the desired setting.

- Press AMP(TUNER) on the component selector.



- Press SET MENU to enter the SET MENU.



- Press PRG- (or PRG+) repeatedly to select the item (1 to 9) you want to adjust.

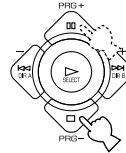

- By pressing SET MENU repeatedly, you can select items in the same order as when pressing PRG-.

- Press - or + once to enter the setup mode of the selected item.

The last setting you adjusted appears on the display.

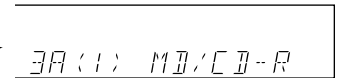
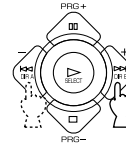

Depending on the item, press PRG- (or PRG+) to select a sub item.

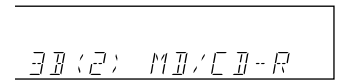
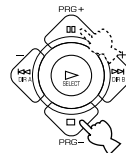

- Press - or + repeatedly to change the setting of the item.

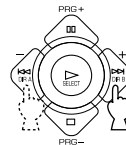

- Press PRG- (or PRG+) repeatedly until the input source name appears to exit from the SET MENU.

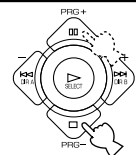

Memory back-up

The memory back-up circuit prevents the stored data from being lost even if this unit is set in the standby mode, the power cord is disconnected from the AC outlet, or the power supply is temporarily cut due to power failure. However, if the power is cut for more than one week, the settings of the SET MENU you adjusted will return to the factory settings. If so, adjust the items again.

1 SPEAKER SET (speaker mode settings)

Use this feature to select suitable output modes for your speaker configuration.

Notes

- When 96-kHz sampling digital signals are input to this unit, level adjustments in items “MAIN SP”, “BASS OUT” and “MAIN LVL” are possible, but those in items “CENTER SP” and “REAR LR SP” are not affected.
- When 6CH INPUT is selected as the input source, level adjustments in items of “1 SPEAKER SET” are not affected (except “MAIN LVL”).

■ CENTER SP (center speaker mode)

By adding a center speaker to your speaker configuration, the unit can provide good dialog localization for many listeners and superior synchronization of sound and images.

Choices: LRG (large), SML (small), NON (none)

Initial setting: LRG

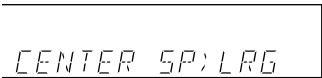

CENTER SP:LRG

LRG

Select this if you have a large center speaker. The entire range of the center channel signal is directed to the center speaker.

SML

Select this if you have a small center speaker. The low-frequency signals (90 Hz and below) of the center channel are directed to the speakers selected with “BASS OUT”.

NON

Select this if you do not have a center speaker. All of the center channel signals are directed to the left and right main speakers.

■ MAIN SP (main speaker mode)

Choices: LARGE, SMALL

Initial setting: LARGE

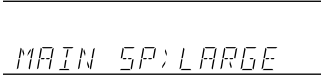

MAIN SP:LARGE

LARGE

Select this if you have large main speakers. The entire range of the left and right main channel signal is directed to the left and right main speakers.

SMALL

Select this if you have small main speakers. The low-frequency signals (90 Hz and below) of the main channel are directed to the speakers selected with “BASS OUT”.

Note

- When you select MAIN for “BASS OUT”, the low-frequency signals (90 Hz and below) of the main channel are directed to the main speakers even if you select SMALL for the main speaker mode.

■ REAR LR SP (rear speaker mode)

Choices: LRG (large), SML (small), NON (none)

Initial setting: LRG



REAR LR SP:LRG

LRG

Select this if you have large left and right rear speakers or if a rear subwoofer is connected to the rear speakers. The entire range of the rear channel signal is directed to the left and right rear speakers.

SML

Select this if you have small left and right rear speakers. The low-frequency signals (90 Hz and below) of the rear channel are directed to the speakers selected with “BASS OUT”.

NON

Select this if you do not have rear speakers.



- This unit is set in the Virtual CINEMA DSP mode by selecting NON for “REAR LR SP”.

■ BASS OUT (bass out mode)

LFE signals carry low-frequency effects when this unit decodes a Dolby Digital or DTS signal. Low-frequency signals are defined as 90 Hz and below.

Choices: SWFR (subwoofer), MAIN, BOTH

Initial setting: BOTH

BASS OUT: BOTH

SWFR

Select this if you use a subwoofer. The LFE signals are directed to the subwoofer.

MAIN

Select this if you do not use a subwoofer. The LFE signals are directed to the main speakers.

BOTH

Select this if you use a subwoofer and you want to mix the main channel low-frequency signals with the LFE signals.

Notes

- When playing a 2-channel source (CD, MD, tape, video cassette etc.), select BOTH position to direct low bass signals (below 90 Hz) to the SUBWOOFER jack.
- When you select SMALL (SML) for items "CENTER SP", "MAIN SP" and "REAR LR SP", the low-frequency signals (90 Hz and below) from those channels are added to the LFE and output to the subwoofer.

■ MAIN LVL (main level mode)

Change this setting if you cannot match the output level of the center and rear speakers with the main speakers because of the unusually high-efficiency performance of the main speakers.

Choices: NORM (normal), -10 dB

Initial setting: NORM

MAIN LVL: NORM

NORM (normal)

Normally select this setting.

-10 dB

Select this if you cannot match the output level of your effect speakers with that of your main speakers when using the test tone. This setting decreases the main speaker output level to about one-third of the normal level.

2 HP TONE CTRL (headphone tone control)

Use this feature to adjust the level of the bass and treble when you use your headphones.

Control range (dB): -6 to +3

Initial setting: 0 dB for both BASS and TRBL (treble)

HP BASS 0dB

HP TREBLE 0dB

3 I/O ASSIGN

It is possible to assign jacks according to the component to be used if this unit's DIGITAL INPUT/OUTPUT jack settings (component names for terminals) differ from that component. This makes it possible to change the jack assignment and effectively connect more component. Once you assign, you can select that component with INPUT </> (or the input selector buttons).

■ 3A (1) (for the OPTICAL OUTPUT jack)

Initial setting: (1) MD/CD-R

3A(1) MD/CD-R

■ 3B (2) to (4) (for the OPTICAL INPUT jacks)

Initial settings: (2) MD/CD-R

(3) DVD

(4) D-TV/CBL

3B(2) MD/CD-R

3B(3) DVD

3B(4) D-TV/CBL

■ 3C (5) (for the COAXIAL INPUT jack)

Initial setting: (5) CD



Note

- You cannot select an item more than once for the same type of jack.

4 INPUT MODE (initial input mode)

Use this feature to designate the input mode when turning on the power of this unit with the source component connected to more than one type of input jacks.

Choices: AUTO, LAST

Initial setting: AUTO



AUTO

Select this to allow this unit to automatically detect the type of input signal and select the appropriate input mode.

LAST

Select this to set this unit to automatically select the last input mode used for that source.

5 DOLBY D. SET (Dolby Digital set)

This setting is effective only when this unit decodes Dolby Digital signals.

■ LFE LEVEL

Use this feature to adjust the output level of the LFE (low-frequency effect) channel when playing back a Dolby Digital signal. The LFE signal carries the low-frequency special effect sound which is only added to certain scenes.

Control value (dB): -20 to 0

Initial setting: 0 dB



Notes

- Adjust the LFE level according to the capacity of your subwoofer.
- Normally, around -6 dB to -8 dB is most suitable for listening at home.

■ D-RANGE (dynamic range)

Use this feature to adjust the dynamic range (the difference between the maximum level and the minimum level of sounds).

Choices: MAX, STD (standard), MIN

Initial setting: MAX



- Select MAX for feature films.
- Select STD for general use.
- Select MIN for listening to sources at an extremely low volume level.

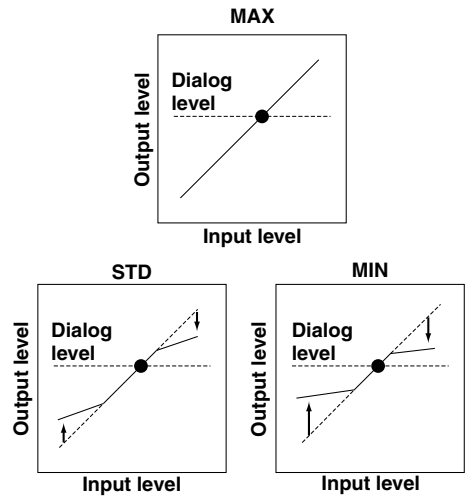

Note

- When you select MIN, the sound output may be faint because some Dolby Digital signals are not compatible with the minimum-level dynamic range. In this case, select MAX or STD.

6 DTS SET (DTS LFE level)

This setting is effective only when this unit decodes DTS signals.

Use this feature to adjust the output level of the LFE (low-frequency effect) channel when playing back a DTS signal. The LFE signal carries the low-frequency special effect sound which is only added to certain scenes.

Control range (dB): -10 to +10

Initial setting: 0 dB



Note

- Adjust the LFE level according to the capacity of your subwoofer.

7 SP DLY TIME (center delay)

Use this feature to adjust the delay of the center channel sound. This feature works when this unit decodes a Dolby Digital or DTS signal. Ideally, the center speaker should be the same distance from the listening position as the left and right main speakers. However, in most home situations, the center speaker is placed in line with the main speakers. By delaying the sound from the center speaker, the apparent distance from the center speaker to the listening position can be adjusted to make it seem the same as the distance between the left and right main speakers to the listening position. Adjusting the delay time for the center speaker is especially important for giving depth to the dialog.

Control range (ms): 0 to 5

Initial setting: 0 ms

CENTER DELAY 0ms

Center speaker image

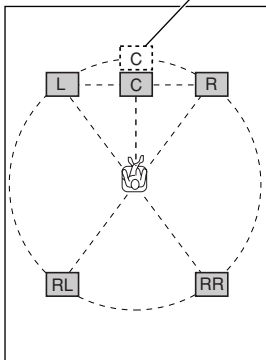

- Increasing the delay by 1 ms simulates moving the speaker about 30 cm (one foot) farther away from the actual position of the center speaker.

8 DISPLAY SET

■ DIMMER

You can adjust the brightness of the display.

Control range : -4 to 0

Initial setting: 0

DIMMER: 0

9 MEM. GUARD (memory guard)

Use this feature to prevent accidental changes to the setting of the SET MENU and other settings on this unit.

Choices: ON, OFF

Initial setting: OFF

MEM.GUARD: OFF

Select ON to protect the following features:

- All SET MENU items
- Center, rear speakers and subwoofer levels
- Delay time adjusted by using TIME/LEVEL

Notes

- When "9 MEM. GUARD" is set to ON, you cannot use the test tone.
- When "9 MEM. GUARD" is set to ON, you cannot select any other SET MENU items.



DELAY TIME AND SPEAKER OUTPUT LEVELS

When using the digital sound field processor with the Dolby Pro Logic decoder, Dolby Digital decoder or DTS decoder, you can adjust the delay time between the main sound and sound effect, and each speaker's output level as you wish.

Delay Time

You can adjust the time difference between the beginning of the sound from the main speakers and the beginning of the sound effect from the rear speakers. The larger the value, the later the sound effect is generated. The delay time can be individually adjusted to all DSP programs.

Notes

- Adding too much delay will cause an unnatural effect with some sources.
- The sound is momentarily interrupted while adjusting the delay time.

	Program	Preset value (ms)
1.	CONCERT HALL	45
2.	JAZZ CLUB	30
3.	ROCK CONCERT	15
4.	DISCO	26
	5CH STEREO	2
	GAME	36
5.	TV SPORTS	10
6.	MONO MOVIE	69
7.	70 mm SPECTACLE	23
	DGTL SPECTACLE	13
	DTS SPECTACLE	13
	70 mm SCI-FI	20
	DGTL SCI-FI	16
	DTS SCI-FI	16
8.	70 mm ADVENTURE	20
	DGTL ADVENTURE	15
	DTS ADVENTURE	15
	70 mm GENERAL	20
	DGTL GENERAL	15
	DTS GENERAL	15
9.	PRO LOGIC/NORMAL	20
	DOLBY DIGITAL/NORMAL	5
	DTS DIGITAL SUR./NORMAL	5
	PRO LOGIC/ENHANCED	20
	DOLBY DIGITAL/ENHANCED	5
	DTS DIGITAL SUR./ENHANCED	5

Sound Output Level of the Center, Right Rear and Left Rear Speakers, and Subwoofer

If desired, you can adjust the sound output level of each speaker even if it has already been adjusted in "ADJUSTING THE SPEAKER BALANCE" procedure.

Notes

- If "CENTER SP" in the SET MENU is set to the NON position, the sound output level of the center speaker cannot be adjusted. This is because the center channel sound is automatically output from the right and left main speakers.
- Once the sound output level has been adjusted, the level will be the same for all DSP programs.

Speaker	Preset value (dB)
Center	0
Right rear	0
Left rear	0
Subwoofer	0

Adjusting Method

Adjustments should be performed with the remote control while watching the information on the display.

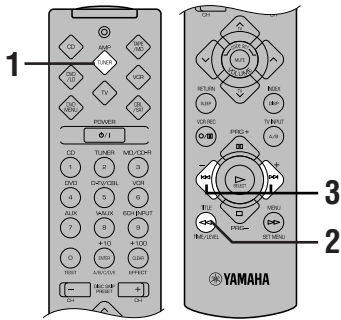

- 3** Press – or + to adjust the delay time or speaker output levels.

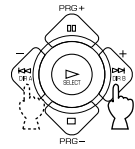

- 4** Repeat steps 2 and 3 to adjust the settings of any other item.

Notes

- If “CENTER SP” or “REAR LR SP” is set to NON, or “BASS OUT” is set to MAIN, the output level of that speaker cannot be adjusted.
- When you adjust the output level with TIME/LEVEL, the settings you made with the test tone will be changed.
- To adjust speakers other than the subwoofer, the adjusting procedure using test tones on page 19 is recommended.

- 1** Press AMP(TUNER) on the component selector.



- 2** Press TIME/LEVEL repeatedly to select the item you want to adjust.

Each time you press TIME/LEVEL, the selected item changes and appears on the display as below.

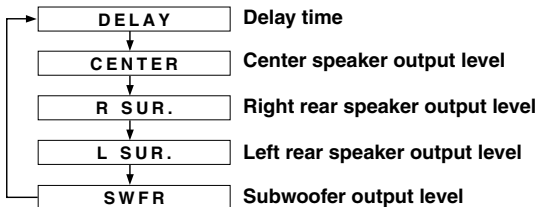

Memory back-up

The memory back-up circuit prevents the stored data from being lost when this unit is set in the standby mode. If, however, the power cord is disconnected from the AC power outlet or the power is cut for more than one week, the latest values for the delay time and the center/rear/subwoofer output levels that were set will automatically return to the preset values. If so, adjust the delay time and output levels again.

Note

- Depending on the setting of the SET MENU, you may not be able to select all these items.



SLEEP TIMER

The SLEEP timer can be used to automatically set this unit in the standby mode. This timer is useful when you are going to sleep while enjoying a broadcast or other desired input source. The SLEEP timer can only be set with the remote control.

Notes

- First press AMP(TUNER), TAPE/MD, CD or DVD/LD on the component selector to set the SLEEP timer for this unit.
- The SLEEP timer is effective for the components connected to the AC OUTLET(S) on the rear panel of this unit.

Setting the SLEEP Timer

1 Play a source you want to enjoy when you are going to sleep.

2 Press SLEEP repeatedly to select the desired SLEEP time.



Each time you press SLEEP, the SLEEP time will change as below:

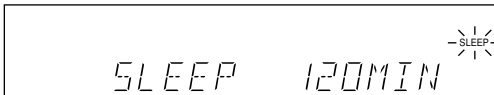
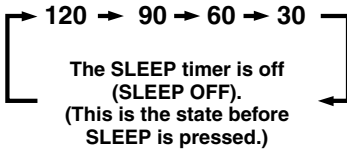

Flashes

3 The “SLEEP” indicator soon lights up on the display after the SLEEP timer has been set.

The display returns to the previous indication.

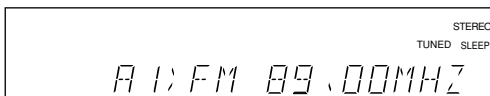

Lights up

Canceling the SLEEP Timer

Press SLEEP repeatedly until “SLEEP OFF” appears on the display.

It will soon disappear and the “SLEEP” indicator will go off.

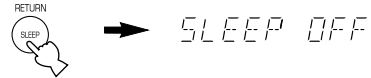

Note

- The SLEEP timer can also be canceled by setting the unit in the standby mode by using POWER on the remote control (or STANDBY/ON), or by disconnecting the AC power cord from the AC power outlet.



PRESET REMOTE CONTROL

It is possible to control this unit and other YAMAHA A/V components using the remote control supplied with this unit. It is also possible to control components from other manufacturers (or some YAMAHA components) by setting the proper manufacturer code (a signal assigned to each manufacturer and component).

Note

- For the notes on batteries, operating distance and names and functions of the remote control, refer to each description in this manual.

Component Selector Buttons

There are eight component selector buttons. Press one of these buttons which corresponds to the component you want to control with the remote control. For example, if you press CD on the component selector, the remote control is set to the CD operation mode, allowing the CD player to be controlled.

AMP(TUNER)

You can perform the basic operations of this unit.

CD

The code for a YAMAHA CD player is factory set.

DVD/LD & DVD MENU

An LD player can be controlled in the DVD/LD mode. A DVD player can be controlled in the DVD/LD and DVD MENU modes. The code for a YAMAHA DVD player is factory set.

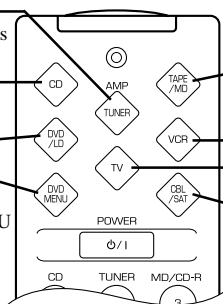

TAPE/MD

The code for a YAMAHA MD deck is factory set. (The code for the YAMAHA CD recorder and tape deck can also be set.)

VCR

A VCR can be controlled.

TV

A TV can be controlled.

CBL/SAT

A cable TV or satellite tuner can be controlled.

Notes

- The button functions on the remote control differ depending on the operation mode. Refer to the following pages for details.
- When shipped from the factory, the YAMAHA manufacturer codes listed on page 49 are set for each dial position. If unable to operate your YAMAHA A/V component, please try using another YAMAHA code.

Controlling the Components Connected to This Unit

Example: To control YAMAHA CD player

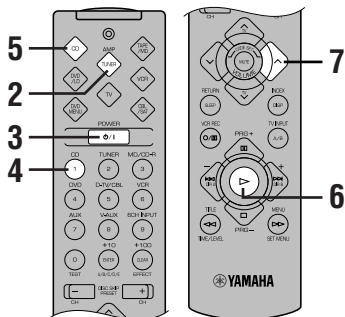

1 Make sure that the volume is set at the minimum level.

2 Press AMP(TUNER) on the component selector.



3 Turn on the power.



4 Press CD on the input selector.



5 Press CD on the component selector.



6 Press .
Refer to "Description of Each Mode" for the CD player operation buttons.

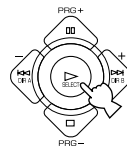

7 Adjust the volume.

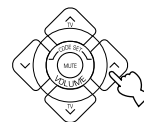

If you set the remote control with the manufacturer codes listed from page i at the end of this manual, you can control other brands of components. Refer to "Setting the Manufacturer Code" for details.

Description of Each Mode

TAPE/MD MODE

Note

- TV VOLUME functions if you have set the code for your TV.

POWER
This button turns this unit on if you have set the code for a YAMAHA tape deck, MD recorder or CD recorder. This button turns on the tape deck, MD recorder or CD recorder that has a remote control with a power button if you have set the code.

Press TAPE/MD.

Input selector buttons

6CH INPUT

EFFECT

TV VOLUME

DISPLAY (MD/CD-R)

DECK A/B (TAPE)
This button selects deck A or B on a double-cassette tape deck.

PAUSE (MD/CD-R)
This button gives a pause in operation.

DIR B (TAPE)
This button selects the playing direction of deck B.

SKIP+ (MD/CD-R)
This button skips to the next track.

STOP
This button stops operation on a tape deck, MD recorder or CD recorder.

FAST FORWARD (TAPE)
This button winds a tape fast forward.

SEARCH (MD/CD-R)
This button initiates a fast-forward search on the track that is playing to find the point from which you want to listen.

REC/PAUSE
This button gives a pause in recording on a tape deck or MD recorder.

PLAY
This button plays a tape, an MD or CD-R.

DIR A (TAPE)
This button selects the playing direction of deck A.

SKIP- (MD/CD-R)
This button skips to the previous track.

REWIND (TAPE)
This button rewinds a tape.

SEARCH (MD/CD-R)
This button initiates a backward search on the track that is playing to find the point from which you want to listen.

- The dark-shaded buttons do not function even if you have set up the manufacturer code.
- Some of them may not function depending on the component you have. In this case, use the original remote control supplied with your component.

CD MODE

Note

- TV VOLUME and TV INPUT function if you have set the code for your TV.

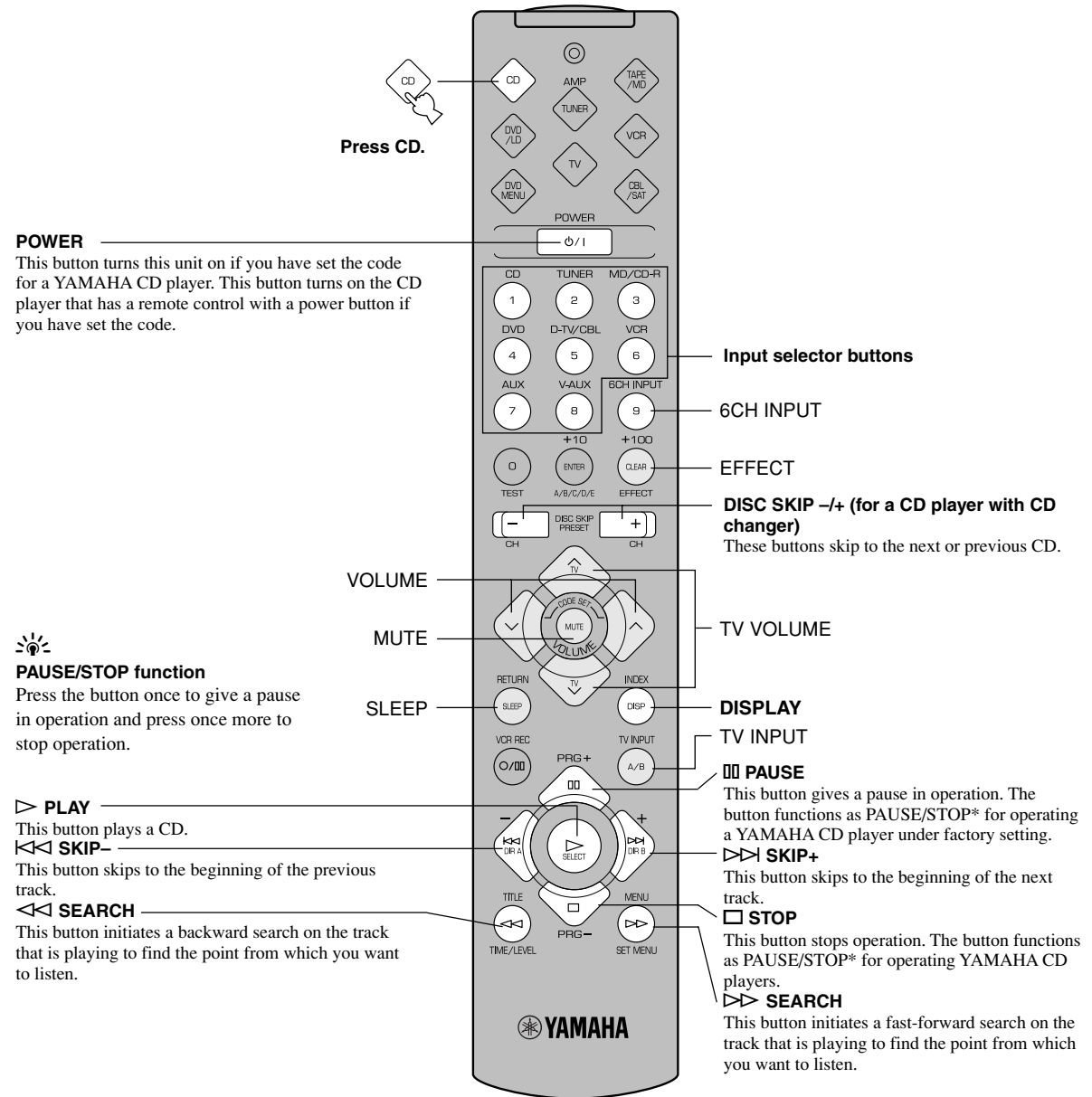

ADVANCED OPERATION

- The dark-shaded buttons do not function even if you have set up the manufacturer code.
- Some of them may not function depending on the component you have. In this case, use the original remote control supplied with your component.

English

DVD/LD MODE

Note

- TV VOLUME and TV INPUT function if you have set the code for your TV.

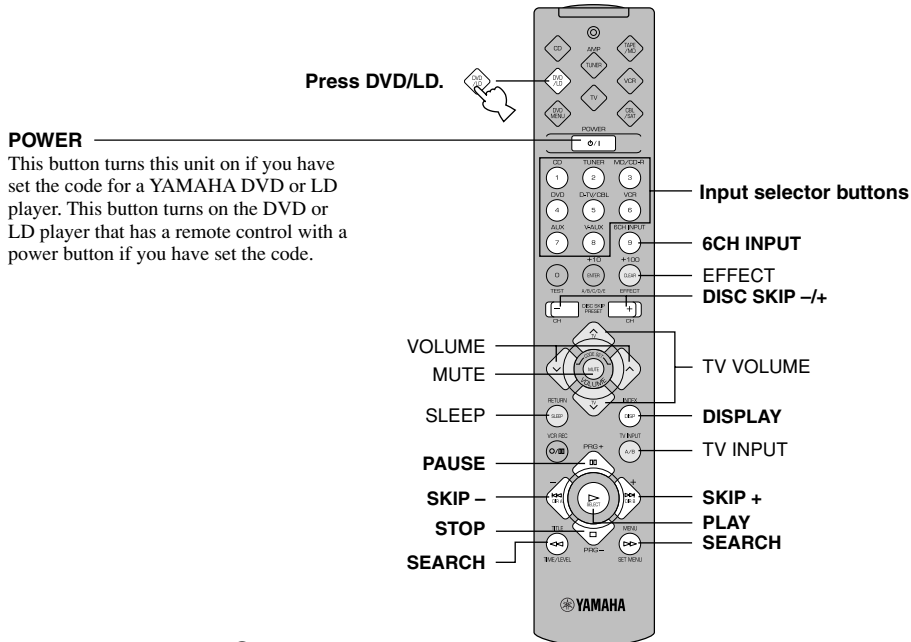

DVD MENU MODE

Notes

- TV VOLUME and TV INPUT function if you have set the code for your TV.
- DVD MENU operations cannot be performed for some DVD players.

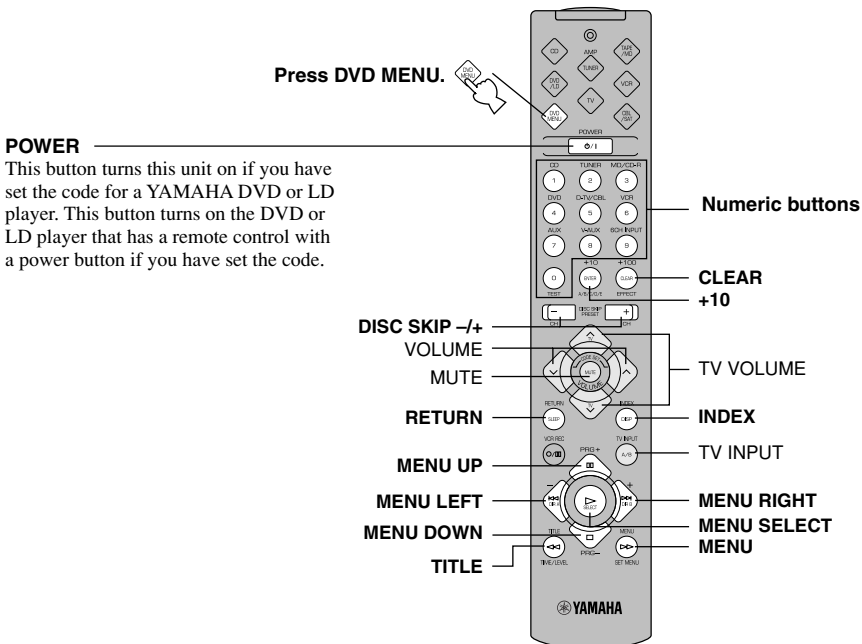

- The dark-shaded buttons do not function even if you have set up the manufacturer code.
- Some of them may not function depending on the component you have. In this case, use the original remote control supplied with your component.

VCR MODE

Note

- TV VOLUME, TV INPUT and TV SLEEP function if you have set the code for your TV.

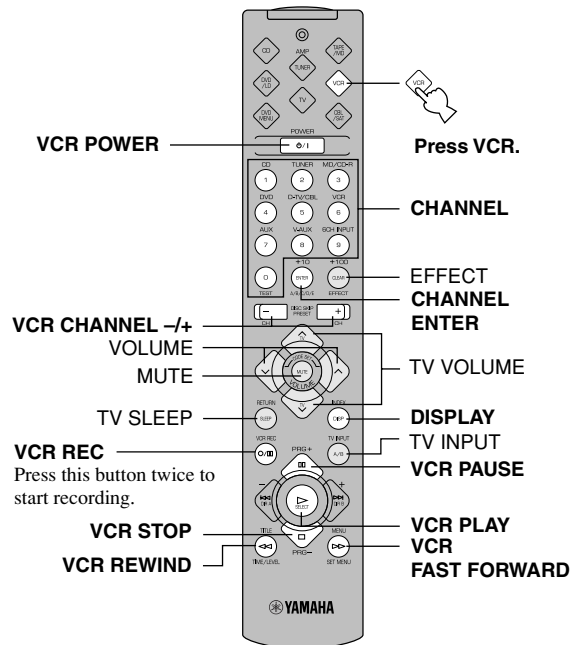

CBL/SAT MODE

Note

- TV VOLUME, TV INPUT and TV SLEEP function if you have set the code for your TV.

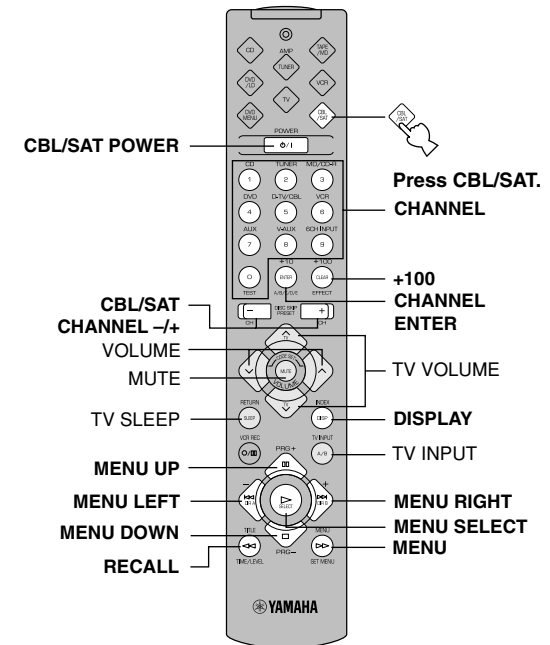

TV MODE

Note

- You can control your VCR if you have set the code for it.

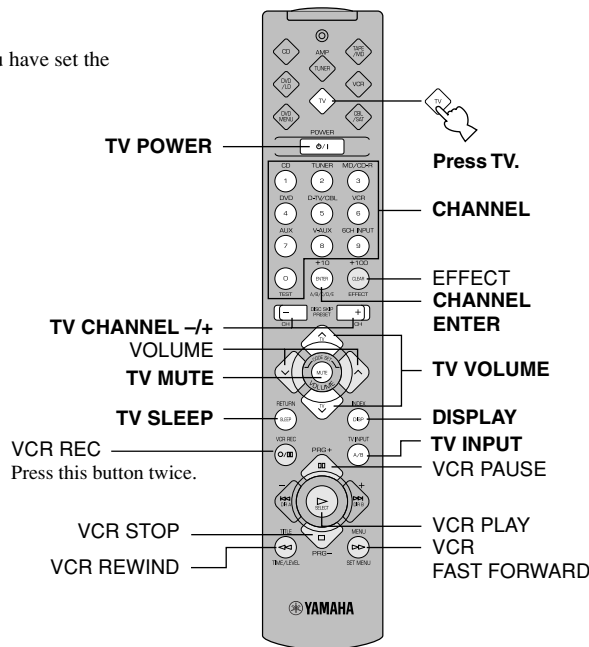

- The dark-shaded buttons do not function even if you have set up the manufacturer code.
- Some of them may not function depending on the component you have. In this case, use the original remote control supplied with your component.

Setting the Manufacturer Code

You can set the code for the manufacturer of your component after pressing the component selector buttons other than AMP(TUNER).

1 Turn on your component to be used.

2 Press one of the component selector buttons which corresponds to the component to be controlled.



3 Press both VOLUME buttons (▲▼) at the same time for about four seconds.

The indicator flashes twice.

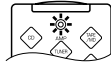

4 Use the numeric buttons to enter the four-digit manufacturer code for the component to be used. Make sure that the indicator flashes twice.

If the indicator does not flash, repeat step 3 and re-enter the code.

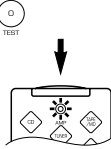
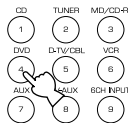

5 Press POWER (or any other button) on the remote control to check if you have set the code correctly.

If your component cannot be controlled with the remote control, try setting another code for the same manufacturer.



Notes

- You can set only one code for one mode.
- In the DVD/LD and DVD MENU modes: Be sure to press DVD/LD on the component selector before entering the code for the DVD/LD player. You cannot set the code for a DVD player after pressing DVD MENU on the component selector. The code set in the DVD/LD mode is also simultaneously set in the DVD MENU mode.
- If your component does not respond to any of the codes listed for the manufacturer, use the original remote control supplied with your component.

To use a second (and third) VCR

You can control a second (and third) VCR in the CBL/SAT and DVD MENU modes if a cable TV or satellite tuner, or DVD player is not being used.

Note

- In order to set a second (and third) VCR in the DVD MENU mode, it is necessary to first set up the code for an LD player in the DVD/LD mode.

1 Turn on the VCR to be used.

2 Press CBL/SAT or DVD MENU on the component selector.



3 Press both VOLUME buttons (▲▼) at the same time for about four seconds.

The indicator flashes twice.

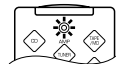
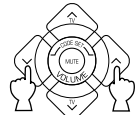

4 Use the numeric buttons to enter the four-digit code for the second (and third) VCR. Make sure that the indicator flashes twice.

If the indicator does not flash, repeat step 3 and re-enter the code.

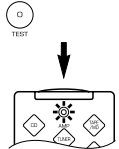
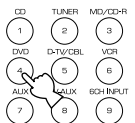

5 Press POWER (or any other button) on the remote control to check if you have set the code correctly.

If the VCR cannot be controlled with the remote control, try setting another code for the same manufacturer.



Returning to the Factory Setting

To return to the factory-set codes in all modes

- 1 Press one of the component selector buttons other than AMP(TUNER).



- 2 Press both VOLUME buttons (▲▼) at the same time for about four seconds.

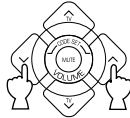

The indicator flashes twice.

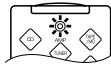

- 3 Enter the code number "9990".

Make sure that the indicator flashes twice.

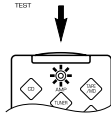
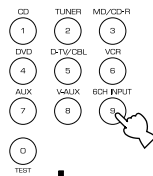

To return to the factory-set codes in each mode

- 1 Press one of the component selector buttons which corresponds to the component to be returned to the factory-set code.



- 2 Press both VOLUME buttons (▲▼) at the same time for about four seconds.

The indicator flashes twice.

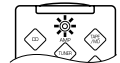
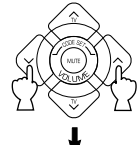

- 3 Enter the code number "0000".

Make sure that the indicator flashes twice.

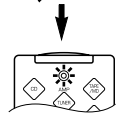
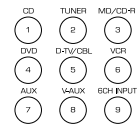

The following codes are factory set.

Component selector button	Component	Code	Set component	Set code
TV	TV	0101		
CBL/SAT	Cable TV	0006		
VCR	VCR	0002		
DVD/LD	DVD player	0008 (YAMAHA DVD player)		
CD	CD player	0005 (YAMAHA CD player)		
TAPE/MD	MD recorder	0024 (YAMAHA MD recorder)		

We recommend that you write all the code numbers you have set on the table above.



SOUND FIELD PROGRAM

A digital sound field processor (DSP) based on the latest YAMAHA technology is built into this unit. It is possible to play back various sound fields for the source you are listening to.

Note

- Regardless of the program name and characteristics listed in the table below, select the sound field program that sounds best to you.

Hi-Fi DSP Programs

■ For audio sources: Nos. 1 to 4

No.	Program (group)	Sub-program	Features
1	CONCERT HALL	—	A large round concert hall with a rich surround effect. Pronounced reflections from all directions emphasize the extension of sounds. The sound field has a great deal of presence, and your virtual seat is near the center, close to the stage.
2	JAZZ CLUB	—	This is the sound field at stage front in “The Bottom Line”, a famous New York jazz club. The floor can seat 300 people to the left and right in a sound field offering a real and vibrant sound.
3	ROCK CONCERT	—	The ideal program for lively, dynamic rock music. The data for this program was recorded at LA’s “hottest” rock club. The listener’s virtual seat is at the center-left of the hall.
4	ENTERTAINMENT	DISCO	This program recreates the acoustic environment of a lively disco in the heart of a big city. The sound is dense and highly concentrated. It is also characterized by a high-energy, “immediate” sound.
		5CH STEREO	Using this program increases the listening position range. This is a sound field suitable for background music at parties.

Note

- Reverberations (sound effects) for realizing the sound field and unprocessed stereo from the left and right main speakers is output. The sound is not output from the center speaker. (The sound is output when one of these programs is selected while playing a source encoded with a Dolby Digital or DTS signal. If 5CH STEREO is selected, the sound is output from all speakers regardless of the input source.)

CINEMA DSP Programs

■ For audio-video sources: Nos. 4 to 6

No.	Program (group)	Sub-program	Features
4	ENTERTAINMENT	GAME	This program adds a deep and spatial feeling to video game sounds.
5	TV SPORTS	—	Although the presence sound field is relatively narrow, the surround sound field employs the sound environment of a large concert hall. With this program, you can enjoy watching various TV programs such as news, variety shows, music programs or sports programs. In a stereo broadcast of a sports game, the commentator is oriented at the center position, and the shouts and the atmosphere in the stadium spread on the surround side, while their spread to the rear is properly restrained.
6	MONO MOVIE	—	This program is provided for reproducing monaural video sources (such as old movies). The program produces the optimum reverberation to create sound depth by using only the presence sound field.

■ For movie programs: Nos. 7 to 9

No.	Program (group)	Sub-program		Input source	Features
7	MOVIE THEATER 1	SPECTACLE	70 mm SPECTACLE	Analog, PCM, Dolby Digital in 2-channel	This program creates the extremely wide sound field of a 70-mm movie theater. It precisely reproduces the source sound in detail, making both the video and the sound field incredibly real. This is ideal for any kind of video source encoded with Dolby Surround, Dolby Digital or DTS (especially large-scale movie productions).
			DGTL SPECTACLE	Dolby Digital (5.1-channel)	
			DTS SPECTACLE	DTS	
		SCI-FI	70 mm SCI-FI	Analog, PCM, Dolby Digital in 2-channel	This program clearly reproduces dialog and sound effects in the latest sound form of science fiction films, thus creating a broad and expansive cinematic space amid the silence. You can enjoy science fiction films in a virtual-space sound field that includes Dolby Surround, Dolby Digital and DTS-encoded software employing the most advanced techniques.
			DGTL SCI-FI	Dolby Digital (5.1-channel)	
			DTS SCI-FI	DTS	
8	MOVIE THEATER 2	ADVENTURE	70 mm ADVENTURE	Analog, PCM, Dolby Digital in 2-channel	This program is ideal for precisely reproducing the sound design of the newest 70-mm and multichannel soundtrack films. The sound field is made to be similar to that of the newest movie theaters, so the reverberations of the sound field itself are restrained as much as possible.
			DGTL ADVENTURE	Dolby Digital (5.1-channel)	
			DTS ADVENTURE	DTS	
		GENERAL	70 mm GENERAL	Analog, PCM, Dolby Digital in 2-channel	This program is for reproducing sounds from 70-mm and multichannel soundtrack films, and is characterized by a soft and extensive sound field. The presence sound field is relatively narrow. It spatially spreads all around and toward the screen, restraining the echo effect of conversations without losing clarity. For the surround sound field, the harmony of music or chorus sounds beautifully in a wide space at the rear of the sound field.
			DGTL GENERAL	Dolby Digital (5.1-channel)	
			DTS GENERAL	DTS	
9	Dolby Digital/DTS SURROUND	NORMAL	PRO LOGIC/NORMAL	Analog, PCM, Dolby Digital in 2-channel	The built-in decoder precisely reproduces sounds and sound effects from sources. The highly efficient decoding process improves crosstalk and channel separation, and makes sound positioning smoother and more precise. In this program, the digital sound field processor is not turned on.
			DOLBY DIGITAL/NORMAL	Dolby Digital (5.1-channel)	
			DTS DIGITAL SUR./NORMAL	DTS	
		ENHANCED	PRO LOGIC/ENHANCED	Analog, PCM, Dolby Digital in 2-channel	This program ideally simulates the multi-surround speaker systems of the 35-mm film theaters. Dolby Pro Logic decoding, Dolby Digital decoding or DTS decoding and digital sound field processing create precise effects without altering the original sound orientation. The surround effects produced by this sound field wrap around the viewer naturally from the back to the left and right, and toward the screen.
			DOLBY DIGITAL/ENHANCED	Dolby Digital (5.1-channel)	
			DTS DIGITAL SUR./ENHANCED	DTS	

Notes

- The “  DSP ” indicator does not light up when selecting the sub-program “NORMAL” of the Dolby Digital/DTS SURROUND program.
- If “CENTER SP” in the SET MENU is set to NON, no sound is output from the center speaker.
- The effect sound is output from the main speakers when a monaural source is played with CINEMA DSP program groups 4 (GAME) and 5 to 8.

MOVIE THEATER 1 and 2

Most commercially available movie software has 4-channel (left, center, right and surround) sound information encoded by Dolby Surround matrix processing and stored on the left and right tracks. These signals are processed by the Dolby Pro Logic decoder. The MOVIE THEATER programs are designed to recreate the spaciousness and delicate nuances of sound that tend to be lost in the encoding and decoding processes.

The 6-channel soundtracks found on 70-mm film produce precise sound field localization and rich, deep sound without using matrix processing. This unit's MOVIE THEATER 70 mm programs provide the same quality of sound and sound localization that 6-channel soundtracks do.

When the input source is analog, PCM or encoded with Dolby Digital in 2-channel

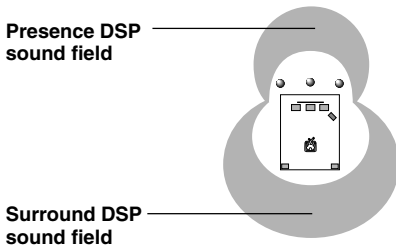

These programs express an immense sound field and a large surround effect. They also give depth to the sound from the main speakers to recreate the realistic sound of a Dolby Stereo theater.

70 mm SPECTACLE
70 mm SCI-FI
70 mm ADVENTURE
70 mm GENERAL

The built-in Dolby Digital or DTS decoder brings the professional-quality sound designed for movie theaters into your home. With the unit's MOVIE THEATER programs, you can recreate a dynamic sound that gives you the feeling of being at a public theater in your listening room by using Dolby Digital or DTS technology.

When the input source is encoded with Dolby Digital (5.1-channel) or DTS (Tri-Field CINEMA DSP)

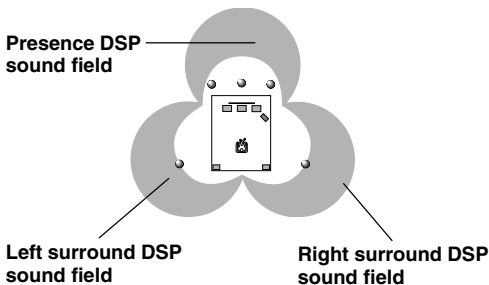

These programs use YAMAHA's tri-field DSP processing on each of the Dolby Digital or DTS signals for the front, left surround and right surround channels. This processing enables this unit to reproduce the immense sound field and surround expression of a Dolby Digital- or DTS-equipped movie theater without sacrificing the clear separation of all channels.

DGTL SPECTACLE
DTS SPECTACLE
DGTL SCI-FI
DTS SCI-FI
DGTL ADVENTURE
DTS ADVENTURE
DGTL GENERAL
DTS GENERAL



- If a Dolby Digital signal or DTS signal is input when the input mode is set to AUTO, the DSP program will be automatically switched to the Dolby Digital playback sound field or DTS playback sound field.



TROUBLESHOOTING

Refer to the chart below when the unit does not function properly. If the problem you are experiencing is not listed below or if the instruction below does not help, set this unit in the standby mode, disconnect the power cord and contact the nearest authorized YAMAHA dealer or service center.

■ General

Problem	Cause	Remedy	Refer to page
The unit fails to turn on when STANDBY/ON (or POWER) is pressed, or enters in the standby mode soon after the power has been turned on.	The power cord is not connected or the plug is not completely inserted.	Firmly connect the power cord.	18
	The IMPEDANCE SELECTOR switch on the rear panel is not fully set to the left or right position.	Set the switch fully to the left or right position when the unit is in the standby mode.	18
	The protection circuit has been activated.	Make sure all speaker wire connections on this unit and on all speakers are secure and that the wire for each connection does not touch anything other than its respective connection.	16, 17
No sound and/or no picture.	Incorrect input or output cable connections.	Connect the cables properly. If the problem persists, the cables may be defective.	12 – 15
	An appropriate input source has not been selected.	Select an appropriate input source with INPUT <1/> or 6CH INPUT (or the input selector buttons).	21
	The speaker connections are not secure.	Secure the connections.	16, 17
	The main speakers to be used have not been selected properly.	Select the main speakers with SPEAKERS A and/or B.	21
	The volume is turned down.	Turn up the volume.	22
	The sound is muted.	Press MUTE or any operation buttons to cancel a mute and adjust the volume.	22
	Digital signals other than PCM audio, Dolby Digital or DTS signal which this unit cannot reproduce are being input to this unit by playing a CD-ROM, etc.	Play a source whose signals this unit can reproduce.	—
The picture does not appear.	The output and input for the video are connected to different types of video jacks.	Make connections using the same type of jack (between composites, S-VIDEOS, or components) for both the input and output.	14, 15
The sound suddenly goes off.	The protection circuit has been activated because of a short circuit, etc.	Check the IMPEDANCE SELECTOR switch is set to the appropriate position and then turn the unit back on.	18
		Check the speaker wires are not touching each other and then turn the unit back on.	16, 17
	The sleep timer has functioned.	Turn on the power, and play the source again.	42
	The sound is muted.	Press MUTE or any operation buttons to cancel a mute and adjust the volume.	22
Only the speaker on one side can be heard.	Incorrect cable connections.	Connect the cables properly. If the problem persists, the cables may be defective.	12 – 17

Problem	Cause	Remedy	Refer to page
No sound from the effect speakers.	The sound effect is off.	Press EFFECT to turn it on.	25
	A Dolby Surround, Dolby Digital or DTS decoding DSP program is being used with material not encoded with Dolby Surround, Dolby Digital or DTS.	Select another DSP program.	50, 51
	A 96-kHz sampling digital signal is being input to this unit.		22
No sound from the center speaker.	The output level of the center speaker is set to minimum.	Raise the level of the center speaker.	40
	“CENTER SP” in the SET MENU is set to NON.	Select the appropriate mode for your center speaker.	36
	One of the Hi-Fi DSP programs (1 to 4) has been selected.	Select another DSP program.	50, 51
	The source encoded with a Dolby Digital or DTS signal does not have a center channel signal.		—
No sound from the rear speakers.	The output level of the rear speakers is set to minimum.	Raise the output level of the rear speakers.	40
	A monaural source is being played with the program 9.	Select another DSP program.	50, 51
No sound from the subwoofer.	“BASS OUT” in the SET MENU is set to MAIN when a Dolby Digital or DTS signal is being played.	Select SWFR or BOTH.	37
	“BASS OUT” in the SET MENU is set to SWFR or MAIN when a 2-channel source is being played.	Select BOTH.	37
	The source does not contain low bass signals (90 Hz and below).		—
Poor bass reproduction.	“BASS OUT” in the SET MENU is set to SWFR or BOTH and your system does not include a subwoofer.	Select MAIN.	37
	The output mode for each speaker (main, center or rear) in the SET MENU does not match your speaker configuration.	Select the appropriate output mode for each speaker based on the size of the speakers in your configuration.	36, 37
A “humming” sound can be heard.	Incorrect cable connections.	Firmly connect the audio plugs. If the problem persists, the cables may be defective.	12 – 15

Problem	Cause	Remedy	Refer to page
The volume level cannot be increased, or the sound is distorted.	The component connected to the REC OUT jacks of this unit is turned off.	Turn on the power to the component.	—
The effect and surround sounds cannot be recorded.	It is not possible to record the effect and surround sounds by a recording component.		34
A source cannot be recorded by a digital recording component connected to the DIGITAL OUTPUT jack of this unit.	A source component is only connected to the analog input jacks of this unit.	Connect the source component to the digital input jacks of this unit.	12 – 15
The settings of the SET MENU and some other settings on this unit cannot be changed.	“9 MEM. GUARD” in the SET MENU is set to ON.	Select OFF.	39
This unit does not operate properly.	The internal microcomputer has been frozen by an external electric shock (such as lightning or excessive static electricity) or by a power supply with low voltage.	Disconnect the AC power cord from the outlet and then plug it in again after about 30 seconds.	—
The sound is degraded when listening with headphones connected to a tape deck or CD player that is connected to this unit.	This unit is in the standby mode.	Turn on the power of the unit.	—
There is noise interference from digital or high-frequency equipment, or the unit.	The unit is too close to the digital or high-frequency equipment.	Move the unit further away from such equipment.	—

■ Tuner

	Problem	Cause	Remedy	Refer to page
FM	FM stereo reception is noisy.	The characteristics of FM stereo broadcasts may cause this problem when the transmitter is too far away or the antenna input is poor.	Check the antenna connections. Try using a high-quality directional FM antenna.	26
			Use the manual tuning method.	27
	There is distortion, and clear reception cannot be obtained even with a good FM antenna.	There is multipath interference.	Adjust the antenna position to eliminate multipath interference.	26
	The desired station cannot be tuned in with the automatic tuning method.	The station is too weak.	Use the manual tuning method.	27
Use a high-quality directional FM antenna.			26	
	Previously preset stations can no longer be tuned in.	The unit has been disconnected for a long period.	Re-store the stations.	28
AM	The desired station cannot be tuned in with the automatic tuning method.	The signal is weak or the antenna connections are loose.	Tighten the AM loop antenna connections and orient it for best reception.	26
			Use the manual tuning method.	27
	There are continuous crackling and hissing noises.	Noises result from lightning, fluorescent lamps, motors, thermostats and other electrical equipment.	Use an outdoor antenna and a ground wire. This will help somewhat, but it is difficult to eliminate all noise.	26
	There are buzzing and whining noises (especially in the evening).	A TV set is being used nearby.	Move this unit away from the TV.	—

■ Remote control

	Problem	Cause	Remedy	Refer to page
	The remote control does not work nor function properly.	Wrong distance or angle.	The remote control will function within a maximum range of 6 m (20 feet) and no more than 30 degrees off-axis from the front panel.	7
		Direct sunlight or lighting (from an inverter type of fluorescent lamp, etc.) is striking the remote control sensor of this unit.	Reposition the unit.	7
		The batteries are weak.	Replace all batteries with new ones.	3
	The unit or other component cannot be controlled.	The component to be controlled has not been selected.	Press one of the component selector buttons, corresponding to the component to be controlled.	43
		The remote control cannot control system components.		—
		The manufacturer code has not been set up properly.	Enter the code again.	48
			Try setting another code for the same manufacturer.	
	Depending on the manufacturer or the model, some components cannot be controlled with this unit's remote control even though the code has been set up properly.	Use the original remote control supplied with your component.	—	

After this unit has been exposed to a strong external electric shock (such as lightning and strong static electricity) or if you mishandle the operation of this unit, it may not function properly. In these cases, set this unit in the standby mode, disconnect the power cord, plug it back in after 30 seconds, and start operating.



SPECIFICATIONS

AUDIO SECTION

- Minimum RMS Output Power for Main, Center, Rear
20 Hz to 20 kHz, 0.06% THD, 8 ohms 70 W
1 kHz, 0.7% THD, 8 ohms 85 W
- DIN Standard Output Power
[Europe model only]
1 kHz, 0.7% THD, 8 ohms 105 W
- IEC Output Power
[Europe model only]
1 kHz, 0.06% THD, 8 ohms 75 W
- Dynamic Power (IHF)
8/6/4/2 ohms 95/115/135/155 W
- Damping Factor
20 Hz to 20 kHz, 8 ohms 60 or more
- Frequency Response
CD, etc. to Main L/R (1 kHz, 150 mV, 8 ohms)
..... 20 Hz to 20 kHz, ± 0.5 dB
- Total Harmonic Distortion
CD, etc. to Main L/R (Effect Off, 20 Hz to 20 kHz, 35 W, 8 ohms)
..... 0.025% or less
- Signal to Noise Ratio (IHF-A Network)
CD, etc. to Main L/R (Effect Off, 250 mV, shorted)
..... 100 dB or more
- Residual Noise (IHF-A Network)
Main L/R 150 μ V or less
- Channel Separation
CD, etc. to Main L/R (1 kHz) 60 dB or more
(10 kHz) 45 dB or more
- Tone Control (Main L/R)
BASS Boost/Cut ± 10 dB/50 Hz
TREBLE Boost/Cut ± 10 dB/20 kHz
- Phones Output (1 kHz, 150 mV, 8 ohms) 490 mV/390 ohms
- Input Sensitivity
CD, etc 150 mV/47 kohms
6CH INPUT 150 mV/47 kohms
- Maximum Input Signal
CD, etc. (1 kHz, 0.5% THD) 2.2 V or more
- Output Level
REC OUT 150 mV/1.2 kohms
SUBWOOFER 4.0 V/1.2 kohms

VIDEO SECTION

- Video Signal Type PAL
- Composite Video Signal Level 1 Vp-p/75 ohms
- S-Video Signal Level
Y 1 Vp-p/75 ohms
C 0.286 Vp-p/75 ohms
- Signal to Noise Ratio 50 dB or more
- Frequency Response (MONITOR OUT)
Composite, S-Video 5 Hz to 10 MHz, -3 dB

FM SECTION

- Tuning Range 87.50 to 108.00 MHz
- Alternate Channel Selectivity (± 400 kHz) 70 dB
- Signal to Noise Ratio (IHF)
Mono/Stereo 76 dB/70 dB
- Harmonic Distortion (1 kHz)
Mono/Stereo 0.2%/0.3%
- Stereo Separation (1 kHz) 48 dB
- Frequency Response 20 Hz to 15 kHz, $+0.5, -2.0$ dB

AM SECTION

- Tuning Range 531 to 1611 kHz
- Usable Sensitivity 300 μ V/m

GENERAL

- Power Supply AC 230 V/50 Hz
- Power Consumption 250 W
Standby Mode 0.96 W
- AC Outlets (Total 100 W maximum)
[Europe model] 2 (SWITCHED)
[U.K. model] 1 (SWITCHED)
- Dimension (W x H x D) 435 x 151 x 390 mm
- Weight 10.0 kg
- Accessories Remote Control
..... Batteries
..... AM loop antenna
..... Indoor FM antenna
..... 75-ohm/300-ohm antenna adapter (U.K. model only)
..... Quick Reference Card
..... Connection Guide

* Specifications are subject to change without notice.



GLOSSARY

■ Dolby Surround

Dolby Surround uses a four analog channel recording system to reproduce realistic and dynamic sound effects: two left and right main channels (stereo), a center channel for dialog (monaural), and a rear channel for special sound effects (monaural). The rear channel reproduces sound within a narrow frequency range.

Dolby Surround is widely used with nearly all video tapes and laser discs, and in many TV and cable broadcasts as well. The Dolby Pro Logic decoder built into this unit employs a digital signal processing system that automatically stabilizes the volume on each channel to enhance moving sound effects and directionality.

■ Dolby Digital

Dolby Digital is a digital surround sound system that gives you completely independent multi-channel audio. With three front channels (left, center and right), and two rear stereo channels, Dolby Digital provides five full-range audio channels. With an additional channel especially for bass effects, called LFE (low frequency effect), the system has a total of 5.1 channels (LFE is counted as 0.1 channel). Using two-channel stereo for the rear speakers, more accurate moving sound effects and surround sound environment are possible than with Dolby Surround. The wide dynamic range (from maximum to minimum volume) reproduced by the five full-range channels and the precise sound orientation generated using digital sound processing provide listeners with previously unheard of excitement and realism.

With this unit, any sound environment from monaural up to a 5.1-channel configuration can be freely selected for your enjoyment.

■ DTS (Digital Theater Systems) Digital Surround

DTS digital surround was developed to replace the analog soundtracks of movies with a six-channel digital sound track, and is now rapidly gaining popularity in movie theaters around the world. Digital Theater Systems Inc. has developed a home theater system so that you can enjoy the depth of sound and natural spatial representation of DTS digital surround in your home. This system is practically distortion-free, clear 6-channel sound (technically, a left, right and center channels, two rear channels, plus an LFE 0.1 channel as a subwoofer, for a total of 5.1 channels).

■ LFE 0.1 channel

This channel is for the reproduction of low bass signals. The frequency range for this channel is 20 Hz to 120 Hz. This channel is counted as 0.1 because it only enforces a low frequency range compared to the full-range reproduced by the other 5 channels in a Dolby Digital or DTS 5.1 channel systems.

■ CINEMA DSP

Since the Dolby Surround and DTS systems were originally designed for use in movie theaters, their effect is best felt in a theater having many speakers and designed for acoustic effects. Since home conditions, such as room size, wall material, number of speakers, and so on, can differ so widely, it's inevitable that there are differences in the sound heard as well. Based on a wealth of actually measured data, YAMAHA CINEMA DSP uses YAMAHA original sound field technology to combine Dolby Pro Logic, Dolby Digital and DTS systems to provide the visual and audio experience of movie theater in the listening room of your own home.

■ SILENT CINEMA

YAMAHA has developed a natural, realistic sound effect DSP algorithm for headphones. Parameters for headphones have been set for each sound field so that accurate representations of all the sound field programs can be enjoyed on headphones.

■ Virtual CINEMA DSP

YAMAHA has developed a virtual CINEMA DSP algorithm that allows you to enjoy DSP sound field surround effects even without any rear speakers by using virtual rear speakers.

It is even possible to enjoy virtual CINEMA DSP in a minimum two-speaker system that does not include a center speaker.

■ S VIDEO signal

With S VIDEO signal system, the video signal normally transmitted using a pin cable is separated and transmitted as the Y signal for the luminance and the C signal for the chrominance through the S VIDEO cable. Using the S VIDEO jack eliminates video signal transmission loss and allows recording and playback of even more beautiful images.

■ PCM (Linear PCM)

Linear PCM is a signal format under which an analog audio signal is digitized, recorded and transmitted without using any compression. This is used as a method of recording CDs and DVD audio. The PCM system uses a technique for sampling the size of the analog signal per very small unit of time. Standing for “pulse code modulation”, the analog signal is encoded as pulses and then modulated for recording.

■ Sampling frequency and number of quantized bits

When digitizing an analog audio signal, the number of times the signal is sampled per second is called the sampling frequency, while the degree of fineness when converting the sound level into a numeric value is called the number of quantized bits.

The range of rates that can be played back is determined based on the sampling rate, while the dynamic range representing the sound level difference is determined by the number of quantized bits. In principle, the higher the sampling frequency, the wider the range of frequencies that can be played back, and the higher the number of quantized bits, the more finely the sound level can be reproduced.

■ I/O ASSIGN (SET MENU)

Although component is normally connected according to jack names shown on the rear panel, this unit includes a function that assigns jacks according to the component being connected. If the component being used differs from the component name shown for this unit's digital input/output jacks, it is possible to assign jacks according to the component being connected. This makes it possible to change the jack assignment and effectively connect more component.



INDEX

A		
AC outlets	18	
Antennas	26	
B		
BALANCE	22	
BGV function	22	
C		
CBL/SAT mode	47	
CD mode	45	
CINEMA DSP	50, 58	
Connections		
Antennas	26	
Audio components (MD recorder, CD recorder and CD player)	12	
External decoder	12	
Power supply cords	18	
Speakers	16	
Video components (DVD player, VCR and TV/digital TV or cable TV/satellite tuner)	14	
D		
Delay time	40	
Display	8	
DISPLAY SET (SET MENU)		
DIMMER	39	
DOLBY D. SET (SET MENU)		
D-RANGE	38	
LFE LEVEL	38	
Dolby Digital	58	
Dolby Surround (Dolby Pro Logic)	58	
DSP program		
CINEMA DSP program	50	
Hi-Fi DSP program	50	
DTS	58	
DTS SET (SET MENU)	38	
Dust protection cap	12	
DVD/LD mode	46	
DVD MENU mode	46	
E		
External decoder	12	
F		
Front panel	4	
H		
HP TONE CTRL (SET MENU)	37	
I		
IMPEDANCE SELECTOR switch	18	
INPUT MODE (SET MENU)	38	
Input modes	23	
I/O ASSIGN (SET MENU)	37, 59	
L		
LFE	38, 39, 58	
M		
Manufacturer codes	48, i	
Memory back-up	28, 36, 41	
MEM. GUARD (SET MENU)	39	
Muting	22	
P		
Package contents	3	
PCM	59	
Playing	21	
Power supply cords	18	
Preset stations		
Exchanging preset station	30	
Tuning in to a preset station	29	
Presetting tuning		
Automatic preset tuning	28	
Manual preset tuning	29	
R		
RDS stations		
EON function	33	
PTY SEEK function	32	
RDS mode	31	
Rear panel	9	
Recording	34	
Remote control		
Basic operation	6	
Batteries	3	
Operation range	7	
Setup codes	48	
S		
Sampling frequency	22, 59	
SET MENU	35	
SILENT CINEMA	25, 58	
Sleep timer	42	
SP DLY TIME (SET MENU)	39	
Speaker		
Output balance (test tone)	19	
Output levels (TIME/LEVEL mode)	40	
Placement	10	
SPEAKER SET (SET MENU)		
BASS OUT	37	
CENTER SP	36	
MAIN LVL	37	
MAIN SP	36	
REAR LR SP	36	
Subwoofer	17	
S VIDEO	59	
T		
TAPE/MD mode	44	
Test tone	19	
Tuning		
Automatic tuning	27	
Manual tuning	27	
TV mode	47	
V		
VCR mode	47	
Virtual CINEMA DSP	25, 58	

**LIST OF MANUFACTURER'S CODES
LISTES DES CODES FABRICANT
VERZEICHNIS DER HERSTELLERCODES
LISTA ÖVER TILLVERKARKODER
ELENCO DEI CODICI DEL FABBRICANTE
LISTA DE CÓDIGOS DE FABRICANTES
LIJST VAN CODES VAN FABRIKANT**

TV		Clarivox	0821, 0961, 1971	First Line	1981	Hitachi	0001, 0011, 0031, 0081, 0141, 0291, 0331, 0341, 0451, 0601, 0631, 0701, 1281, 1561, 1601, 1821, 1831, 1841, 1861, 1871, 1881, 1891, 1941, 1981, 2051, 2321, 2341
Admiral	0411, 0451, 0911, 1021, 1081	Clatronic	1181, 1331	Fisher	0021, 0091, 0141, 0511, 0601, 0801, 0821, 0981, 1021, 1081, 1981, 2091		
Aiko	0891	Concerto	0791	Forgestone	2281		
Akai	0061, 0101, 0231, 1191, 1351, 1591, 1641, 1791, 1891, 1981	Condor	0761	Formenti	0451, 0491, 0761, 1081, 1451, 1541, 1981		
Akura	1331	Contec	0151, 1171	Formenti-phoenix	0021, 0431, 0451, 0591, 1411	Hyper	0591, 0601, 1511, 1621
Alba	1241, 1331, 2361	Continental Edison	0571, 0651, 0901			Imperial	0451, 0491, 0811, 0981, 1401, 1611, 1621, 2201, 2251, 2271
Albiral	1971	Craig	1171	Fortress	1081		
Amstrad	1301, 1511	Crosley	0021, 0491, 1021, 1081, 1401, 1981, 2201, 2251, 2271	Frontech	0451, 1181, 1981		
Anam	1171	Crown	2541	Fujitsu	1261		
Arc En Ciel	0571	Ctc Clatronic	0261	Funai	0391, 0691, 1171, 1181, 1261	Ingersol	1511
Arcam	0571, 0761	CXC	1171	Futurtech	1171	Inno Hit	0581, 0601, 0841, 1101, 1331, 1371, 1511, 2011
Aristona	0751	Daewoo	0101, 1501, 1511, 2611	GBC	0021, 0141, 1321, 1511, 1621, 1981	Innovation	2591, 2601, 2611, 2621, 2641, 2651, 2661, 2711, 2721, 2761, 2771, 2781
Arthur Martin	0451, 1641	Dansai	0101	GEC	0451, 1101, 1281, 2321		
ASA	0411, 0451, 0521, 0781, 0871, 1021, 1081, 1421, 2051, 2091, 2151, 2551	Decca	0271, 0581, 0601, 0971, 1101, 1691	GEC (UK)	0031, 0081, 0581, 0601, 1101, 1281, 1561	Interfunk	0031, 0041, 0061, 0121, 0181, 0451, 0491, 1081, 1641, 1791, 1821, 1981, 2231
Astra	1511	Decca (UK)	0271, 0581, 0601, 1101, 1681	Geloso	0021, 0411, 0451, 1321, 1511, 1621, 1981		
Atantic	0761	Degraaf	0451, 1351	General Technic	2681	Irradio	0491, 1321, 1331, 1371, 1411, 1511, 2011
Atlantic	0761	Dixi	0991, 1511	Genexxa	0451, 1331		
Atori	1511	Domeos	0101	GoldStar	0591, 0601, 0761, 0791, 1371, 1491, 1511, 1561, 1621, 1641	Isukai	1331
Audiosonic	1181, 1321, 1511	Doric	1031			ITT	0031, 0041, 0051, 0061, 0071, 0081, 0181, 0411, 0451, 0491, 1241, 1291, 1351, 1501, 1601, 1641, 1741, 1921, 1981, 2091, 2331, 2431
Ausind	0491, 1411	Dual	0091, 0601, 1611, 1641, 2101				
Autovox	0091, 0351, 0481, 0491, 0601, 0781, 0951, 1051, 1081, 1391, 1421	Dual-Tec	0601, 1511, 1621, 2111	Granada	0141, 0451, 0491, 0581, 0601, 1101, 1111, 1351, 1981, 2321	ITT-nokia	0031, 0041, 0051, 0061, 0071, 0081, 0181, 0411, 0451, 0491, 1241, 1291, 1351, 1501, 1601, 1641, 1741, 1921, 1981, 2091, 2331, 2431
Baird	1101, 1351	Dumont	0261, 0521, 0781, 1021, 1081, 1981, 2121, 2151	Granada (UK)	0081, 0141, 0451, 0491, 0581, 0601, 1031, 1311, 1521, 1561, 1641		
Bang & Olufsen	1081	Dynatron	0101				
Basic Line	1321, 1331	Elbe	1551, 1971, 2031	Grundig	0221, 0231, 0471, 0491, 0711, 0741, 1381, 2021, 2041, 2141, 2151	JVC (Victor)	0071, 0721, 1441, 1581, 1591, 1741, 1791
Bauer	1451	Electro Tech	1511	Hanseatic	0021, 0121, 0141, 0431, 0591, 1561	Kaisui	0591, 1321, 1331
Baur	0041, 0061, 0121, 0131, 0221, 1561	Elektronska	0771			Kamosonic	0601
Beko	2491, 2501	Elman	0261, 1621	Gorenje	0981, 1061	Karcher	0591, 0601, 0841, 1091, 1321, 1511, 1561, 2051
Blaupunkt	0221, 0231, 0241, 0251, 0471, 0741, 2201, 2211, 2221, 2231, 2241, 2261, 2571, 2581	Elta	1511	Graetz	0451		
Brandt	0571, 0651, 0731, 0901, 1821	Emerson	0921, 1021, 1081, 1121, 1171, 1261, 1301	Granada	0141, 0451, 0491, 0581, 0601, 1101, 1111, 1351, 1981, 2321		
Brionvega	1021, 1051, 1081	Erres	0101				
Britannia	0761	Etron	1981				
Bruns	0821, 0991, 1021, 1081	Europhon	0261, 0581, 0601, 0771, 1091, 1621, 2001				
BSR	0391, 0691, 1621, 1901, 1981	Fenner	0101, 1511				
Bush	0451, 1241, 1331, 1641, 1741, 2131, 2151	Ferguson	0281, 0371, 0551, 0651, 0781, 0861, 0881, 1131, 1181, 1361, 1461, 1971, 1991, 2281, 2311, 2341				
Bush (UK)	0481, 1561, 1611	Fidelity	0451, 0761, 2281				
Candle	0791	Fidelity (UK)	0561, 0591, 1931, 2281				
Century	1021, 1081	Filmnet	1141				
CGE	0491, 0811, 0981, 1401, 1531, 1611, 1621, 1981, 2201, 2251, 2271	Finlandia	0451, 2321				
Citizen	0791	Finlux	0021, 0261, 0491, 0521, 0781, 0811, 0871, 1081, 1411, 1421, 1981, 2051, 2091, 2121, 2151, 2551				

Konka	2701	NEC	0141, 1711, 1721,	Prandoni-promce	0451, 0491,	Seleco	0071, 0101, 0351,
Korting	0431, 1011, 1021,		1731		0581		0411, 0451, 0951,
	1081, 1541	Neckermann	0451, 0601, 0981,	Prima	0451		1901, 2061, 2101,
KTV	0601, 1171		1081, 1561, 1931,	Profex	1981		2111
Lenoir	0601, 1511		1981, 2211, 2231,	Protech	0641, 1181, 1981	Sentra	1601
Leyco	1181		2241	Quelle	0041, 0061, 0121,	Sharp	0141, 0151, 0191,
Lifetec	2591, 2601, 2611,	Nediator	0101		0221, 0231, 0391,		1761, 1781
	2621, 2641, 2651,	Nicamagic	0761		0491, 0521, 0601,	Siarem	0021, 0261, 0581,
	2661, 2671, 2681,	Nikkai	1101, 1331, 1641,		0781, 1371, 1381,		0641, 1021, 1081,
	2691, 2711, 2761,		1701, 2011		1411, 1421, 1641,		1981
	2771, 2781	Noblisko	0261, 0491, 0591,		1681, 2051, 2091,	Sicatel	1971
Loewe Opta	0121, 0131, 0581,		0641, 1381, 1411		2141, 2151, 2201,	Siemens	0151, 0221, 0231,
	0611, 1081	Nogamatic	0571		2211, 2231, 2241,		0451, 0741, 2011,
Logic	1691, 2281	Nokia	0031, 0041, 0051,		2251, 2271, 2551,		2201, 2211, 2221,
Logik	0551, 1681, 2281		0061, 0071, 0081,	Radiomarelli	2571, 2581		2231, 2241, 2261,
Lowewe	0831		0181, 0411, 0451,		0101, 0451, 0661,		2571, 2581
Luma	0351, 0451, 1901		0491, 1241, 1291,		0771, 1081	Silver	1181
Luxman	0791		1351, 1501, 1601,	Radionette	0031, 2051, 2091	Singer	0021, 0261, 1021,
Luxman Stereo Tuner	0791		1641, 1741, 1921,	Radiola	2291		1081
Luxor	0001, 0061, 0181,		1981, 2091, 2331,	Rank	0481, 2151	Sinudyne	0101, 0021, 0061,
	0341, 0421, 0451,		2431, 2461, 2791	Rbm	2131, 2151		0261, 0391, 0641,
	0461, 0491, 0601,	Nordmende	0031, 0291, 0331,	Rbm (UK)	0481		0691, 0851, 0941,
	0671, 1351, 1371,		0451, 0531, 0541,	Rediffusion	0451, 0661, 1641,		1021, 1081, 1241,
	1561, 1601, 1911,		0571, 1051, 1131,		1981, 2331		1301, 1321, 1481,
	1921, 1981		1591, 1791, 1811,	Rediffusion (UK)	0061, 0081,		1631, 1981
Lycor	1181		1821, 1891, 1941,		1031	Skantic	0451
Magnadyne	0021, 0061, 0261,		2631	Rex	0071, 0101, 0351,	Solavox	0451, 1641, 2011
	0581, 0641, 0771,	Oceanic	0321, 1651, 1981		0411, 0451, 0951,	Sonoko	1181, 1511, 0101
	1021, 1081, 1621,	Oceanic (F)	0031, 0061, 0321,		1901, 2061, 2101,	Sony	0141, 0171, 1121,
	1981		0441, 1661		2111		1681, 1691, 2751
Magnafon	0261, 0491, 0581,	Onceas	0601	Rft	0991, 2511	Soundesign	1171
	0591, 0641, 0761,	Onwa	1171	Roadstar	1321, 1511	SSS	1171
	1091, 2001	Orion	0061, 0391, 0691,	Rotel	0151	Stern	0071, 0101, 0351,
Manesth	0101		0851, 1211, 1241,	Saba	0291, 0331, 0421,		0411, 0451, 0951,
Marantz	0101		1251, 1301, 1481,		0451, 0531, 0541,		1901, 2061, 2101,
Marelli	1081		1511, 1681, 1691,		0571, 0581, 0651,		2111
Mark	0101		1981, 2371, 2421		0731, 0931, 1021,	Sunkai	0691
Matsui	0061, 0451, 0601,	Osaka	2011		1071, 1081, 1131,	Supra	0791
	0691, 1101, 1151,	Osaki	1101, 1331, 2011		1791, 1811, 1821,	Tandberg	0161, 0331, 0611,
	1241, 1271, 1301,	Osune	0151		1891, 1941, 2631		1021, 1421, 1771,
	1511, 1561, 1681,	Otto Versand	0021, 0121, 0141,	Saccs	1971		1791, 2081
	1691		0221, 0601, 1561,	Saisho	0451, 0601, 1161,	Tandy	0451, 0191, 1331,
Maximal	0071, 1981		1741, 1981		1241, 1301, 1511,		1531
McMichael	1281	Pael	0591, 1411		1671, 1681, 1691	Tashiko	0141
Medion	2591, 2601, 2611,	Panasonic	0031, 0201, 0211,	Salora	0011, 0041, 0061,	Tatung	0271, 0581, 0601,
	2621, 2641, 2651,		0451, 0701, 1311,		0071, 0341, 0451,		0971, 1101, 1681,
	2661, 2671, 2681,		1751, 1961, 2561,		0671, 1291, 1351,		1691
	2691, 2711, 2721,		2741		1521, 1561, 1601,	Tem	2621, 2641, 2711,
	2761, 2771, 2781	Panoramic	2351		1641, 1911, 1921,		2761, 2771, 2781
Memorex	1511	Pathe Marconi	0571		1931, 1981, 2321	Technics	1311
Metz	0231, 0741, 1001,	Pathe' Cinema (F)	0431, 0591,	Sambers	0261, 0491, 0581,	Techwood	0791
	1041, 1081, 1481,		1621, 1661,		0641, 1091, 1371,	Teknika	1171, 1231, 1261
	2071, 2081		1971		1411, 2001	Tele	1141
MGA	1231	Pausa	1511	Samsung	0101, 0601, 0841,	Teleavia	0571, 0651, 0731,
Micromaxx	2591, 2621, 2641,	Pauza	1511		0981, 1101, 1181,		1821
	2651, 2711, 2761,	Perdio	0891, 1101		1371, 1511, 2011	Telefunken	0291, 0301, 0311,
	2771, 2781	Philco	0021, 0491, 0811,	Sanyo	0141, 0151, 0401,		0551, 0731, 1131,
Minerva	0221, 0231, 0491,		0981, 1021, 1081,		0601, 0801, 0821,		1471, 1591, 1791,
	1381, 2141, 2151		1401, 1611, 1621,		0981, 1021, 1101,		1801, 1811, 1821,
Mistral	2281		1751, 2201, 2251,		1111, 1291, 1351,		1991, 2161, 2171,
Mitsubishi	0141, 0201, 0231,		2271, 2451, 2471		1691, 1741, 2051,		2181, 2191, 2201,
	0661, 1191, 1201,	Philips	0101, 0361, 0591,		2091, 2551		2251, 2271, 2521,
	1231, 1671, 1691,		0621, 0681, 0751,	SBR	0681, 0751, 1281,		2631
	1741		0761, 1021, 1081,		2281	Teletech	1511
Mivar	0491, 0501, 0581,		1281, 2031, 2281,	Schaub Lorenz	0451	Tempest	2381, 2391, 2401,
	0591, 0761, 0771,		2291, 2431, 2441,	Schneider	0021, 0071, 0091,		2411
	1371, 1431, 2031		2511, 2731		0451, 0511, 0591,	Tensai	1331, 2091
MTC	0791	Phoenix	1081		0601, 0751, 1321,	Texet	0601
Multitech	0261, 0581, 0601,	Phonola	0751, 1081		1361, 1621, 1641,	Thomson	0331, 0481, 0531,
	0641, 0981, 1321,	Pioneer	0291, 0451, 1341,		2101, 2111, 2291		0571, 0631, 0651,
	1511		1821	Scott	1171, 1261		0731, 0901, 1241,
Murphy	0451, 2091	Prandoni-prince	0411, 0451,	SEG	0261, 0601, 0821,		1571, 1591, 1791,
Murphy (UK)	0081, 1031		0491, 0581,		0991		1811, 1821, 1891,
N.E.I.	0101, 0961		1411	SEI	0641, 0691, 1081,		1941, 2531
NAD	1341				1301, 1481, 1981	Thorn	0741, 0861, 2091,
							2251, 2271, 2281

Thorn-Ferguson 0281, 0371, 0551, 0651, 0781, 0861, 0881, 1131, 1181, 1361, 1461, 1971, 1991, 2281

TMK 0141, 0791, 1471

Toshiba 0141, 0381, 0481, 1221, 1271, 1701, 1741, 1851, 2151, 2801, 2811

Trans Continens 0451

Tristar 2281

Triumph 0481, 0581, 2121

Uher 0431, 0451, 0481, 0491, 0511, 1311, 1541

Ultravox 0021, 0261, 0591, 1021, 1081, 1981

Universum 1181, 2051

Univox 1971

Vegavox 0811

Vexa 0101, 1511

Videoton 2481

Vortec 0101, 0651

Voxson 0411, 0451, 0491, 1021, 1081

Waltham 0451

Watson 0431, 2201, 2241

Watt Radio 0021, 0061, 0261, 0591, 0641, 0761, 1091, 1971, 1981, 2001

Wega 0141, 1081, 1981

Wega Color 1021

Weltblick 0101

Weston 1621

White Westinghouse 0101, 0261, 0431, 0591, 0761, 1401, 1541

Yoko 0601, 1511

Zanussi 0071, 0101, 0351, 0411, 0451, 0951, 1901, 2061, 2101, 2111

Zoppas 0451

CABLE

Cabletime 1446, 1456, 1476

Clyde Cablevision 1426

Filmnet 1396, 1436

France Telecom 1386

GEC 1426

Jerrold 1416

Movie Time 1466

NSC 1466

Philips 1386

Pioneer 0006

Samsung 1496

Scientific Atlanta 1486, 1506

Starcom 1416

STS 1466

Tele 1436

Tele+1 1436

Teleservice 1406, 1476

Tudi 1376

United Cable 1416

Zenith 1406

SATELLITE TUNER

Akai 1276

Alba 0826, 1276

Amstrad 0166, 0796, 1016, 1026, 1296

Ankaro 0476

Ast 0406

Astra 0126

Barcom 0476

Blaupunkt 0966

Bmc Satellite 0106

British Telecom 1276

Bush 0826

Bush (UK) 0956

Cambridge 0196, 1276

Chaparral 0016, 0696, 1006

Columbus 0616

Connexions 0306, 0426

Discus Elipse 0856, 0866

Diskxpress 0426, 0476

Drake 1516

Echostar 0226, 0236, 0606, 0626, 0666, 0926, 0996, 1046, 1056, 1066, 1106

Elta 1286

Elta Sat 0146

Eurodec 1226, 1236, 1246

Ferguson 0046, 0176, 0186, 0296, 0846, 0956, 1306

Finlux 0976

Fracarro 0026, 0536, 0776

Fuba 0476, 0616, 0636, 1056

Giucar Record 0206, 0336

Grundig 0176, 0946, 0956, 0966

High Performance 0916

Hirschmann 0756, 0966

Hitachi 0446, 0516, 0706, 0946

Icx International 0886

ITT 0066, 0126, 0176, 0446, 1156

ITT/Nokia 0066, 0126, 0176, 0446, 1156

Jeemon 0146

Jerrold 0846, 0986

Johansson 0246

JVC (Victor) 1276

Kathrein 0116, 0266, 0276, 0366

Kosmos 0266

Kyostar 1036, 1086

Leng 0246

Lifesat 1326, 1346, 1356

Luxor 0126, 0136, 0446, 0466, 0506, 1156

Macab 0356

Maspro 0016, 0116, 0256, 0956

Medion 1326, 1346

Metz 0966

Micromaxx 1326, 1346

Mitsubishi 0966

Morgans 0596

Muratto 0406

NEC 0286, 0316, 0766, 0786, 0836

Network 0046

Nikko 1136, 1146

Nokia 0066, 0126, 0176, 0446, 1156, 1166, 1336

Norsat 0786

Otto Versand 0966

Pace 0046, 0176, 0296, 0936, 0956, 1306

Pace Mss 0946

Palcom 0616, 0686, 0706

Palsat 0396

Paltec 0706

Panasonic 0806, 1306

Pansat 1076

Philips 0326, 0346, 0476, 0956, 1126, 1186, 1196, 1206, 1216, 1306, 1316

Prosat 1176

Ptt Telecom 0306, 0896

Quelle 0966

Radix 1056

Rediffusion 0316, 0786

Rft 1186, 1196, 1206, 1216

Sagem 1256

Sakura 0566, 0816

Salora 0066, 0126, 0136, 0446, 0456, 0486, 0496, 0576

Samsung 0746, 0756

Sat 0406

Satcom 0896

Sateco 0646

Sector 1266

Sedea 1096

Sentra 0416

Siemens 0896, 0966

Sintrack 0906

Skylab 0476

Skyscan 0876

Sony 0736, 0946

Stella 0306

Strong 0156, 0396, 1036, 1086

Stv 0636

Tandberg 1116, 1366

Tandy 0916

Tantec 0616

Tatung 0516, 0546

Technisat 0086, 0096, 0526, 0556, 1056

Telecom 0306

Telemax 0586

Thorn-Ferguson 0046, 0076, 0176, 0186, 0956

Toshiba 0946

Triad 0406

Uniden 0036, 0216, 0676, 0716, 0726

US Electronics 0886

Vortec 0756, 1036, 1076

Vtech 0436

Winersat 0246

Wisi 0056, 0356, 0376, 0386, 0406, 0656, 1056, 1156

Wolsey 0916

Zehnder 0266, 0406

Zender 0406

VCR

Aiwa 0042, 0352, 0432

Akai 0042, 0422, 0492, 0582, 0612, 0642, 0652, 0762, 0912

Alba 0002, 0112, 0282, 0332, 0342, 0972

Amstrad 0322, 0432, 0452

Anitech 0002

Anitsch 1002

ASA 0012, 0052

Audiosonic 0002

Baird 0042, 0282, 0492

Bang & Olufsen 0042

Baur 0052, 0062, 0812

Blaupunkt 0062, 0092, 0252, 0462, 0672, 0992

Brionvega 0032

Bush 0002, 0282, 0332, 0342, 0512, 0972

Bush (UK) 0812

Capehart 0112

CGE 0042, 0432, 0762

Craig 0072, 0482

Crown 0112, 0282, 1212

Daewoo 0112, 0282, 1212

Dansai 0012

Daytron 0112

Decca 0042, 0052, 0432, 0942

Decca (UK) 0052

Degraaf 0052, 0132, 0432, 0532, 0602

Dixi 0442

Dual 0042, 0632

Dumont 0052, 0432, 0532

Dynatech 0432

Dynatron 0012

Elbe 0122

Elin 0072

Emerson 0012, 0162, 0202, 0432, 0512, 0522

Erres 0012

Ferguson 0042, 0712, 0722, 0852, 0902, 1012, 1022, 1082

Fidelity 0432

Finlandia 0052, 0532

Finlux 0012, 0042, 0052, 0082, 0262, 0382, 0432, 0462, 0492, 0532, 0572, 0602, 0912

First Line 0002, 0912

Fisher 0162, 0482, 0532, 0542, 0572, 0592

Formenti-Phoenix 0012, 0052

Frontech 0112

Funai 0432

GBC 0002

GEC (UK) 0022, 0052

Geloso 0002

General Technic 1172

GoldStar 0012, 0812, 0952, 1202

Goodmans 0002, 0072, 0282, 0432, 0502

Goodmans (UK) 0002

Graetz 0022, 0042

Granada 0052, 0132, 0532, 0572

Granada (UK) 0052, 0092, 0462, 0602, 0812, 0822

Grundig	0052, 0062, 0092, 0232, 0252, 0262, 0752, 0802	Nordmende	0042, 0102, 0142, 0192, 0222, 0242, 0392, 0402, 0632, 0732, 0742, 0762, 0782, 0792, 0832, 0842, 0872	STS	0602		
Hanseatic	0052, 0812			Sunkai	0512		
Harman/Kardon	0922, 1202			Sunstar	0432		
Hcm	0002			Sylvania	0432, 0912		
Hinari	0002, 0202, 0412, 0442, 0522	Olympus	0462	Symphonic	0432, 0912		
Hitachi	0042, 0172, 0292, 0432, 0602, 0662, 0812, 1022	Optonica	0132, 0502	Tandegerg	0062, 0162, 0522, 0932		
Imperial	0072, 0432	Orion	0162, 0202, 0312, 0442, 0512, 0522, 0982	Tashiko	0132, 0432		
Ingersol	0442	Osaka	0432	Tatung	0042, 0052, 0432, 0922		
Inno Hit	0002, 0052, 0072	Osaki	0002, 0012, 0432	TCM	1142, 1162, 1172		
Innovation	1142, 1162, 1172	Otto Versand	0052, 0062, 0812	Teac	0042, 0432		
Interfunk	0022, 0052	Panasonic	0022, 0212, 0462, 0672, 0992, 1092, 1102, 1182	Technics	0462		
Irradio	0002, 0012			Teknika	0012, 0432		
ITT	0022, 0032, 0042, 0072, 0292, 0492, 0532, 0572, 0762	Pentax	0172, 0602	Telefunken	0042, 0192, 0632, 0732, 0742, 0762, 0782, 0882, 0892		
ITT-Nokia	0022, 0032, 0042, 0072, 0292, 0492, 0532, 0572, 0762	Perdio	0432	Tempest	1032, 1042, 1052		
Jensen	0042	Philco	1062	Tenosal	0002		
JVC (Victor)	0042, 0102, 0142, 0272, 0742, 0762, 0782, 0902	Philips	0052, 0082, 0092, 0152, 0182, 0362, 0372, 0472, 0502, 1072	Thomson	0042, 0102, 0142, 0192, 0402, 0632, 0762		
Karcher	0052, 0072, 0812	Phonola	0052, 0152	Thorn	0042, 0902		
Kendo	0492	Pilot	0012	Thorn-Ferguson	0042, 0222, 0302, 0712, 0722, 0742, 0762, 0852, 0862, 0872, 0902		
Kenwood	0042, 0142, 0572	Pioneer	0052, 0142, 0372, 0472	TMK	0522		
Lifetec	1142, 1162, 1172	Portland	0112	Tonsai	0002		
Lloyd	0432	Proline	0432	Toshiba	0042, 0622, 0912, 1212		
Loewe Opta	0052, 0092, 0152	Pye	0052, 0152	Totevision	0012, 0072		
Logik	0002, 0072, 0442	Quartz	0572	Triumph	0922		
Luma	0162	Quelle	0012, 0032, 0042, 0052, 0062, 0072, 0092, 0202, 0462, 0552, 0942	Uher	0042, 0072		
Luxor	0492, 0572, 0812			Ultravox	0032		
M Electronic	0432	Radionette	0022	Unitech	0072		
Magnadyne	0052	Realistic	0012, 0072, 0132, 0432, 0482, 0502, 0532, 0572	Vector Research	0122		
Magnasonic	0572			Videon	1162, 1172		
Manesth	0012	Ret	1072	Weltblick	0012		
Marantz	0012, 0052, 0092, 0502, 1202	Rex	0042, 0742, 0782	White Westinghouse	0032		
Mark	0012	Ricoh	0952	Xenon	0162		
Marta	0012	Saba	0042, 0142, 0192, 0222, 0242, 0392, 0632, 0732, 0742, 0762, 0772, 0782, 0792, 0872	Yamaha	0042, 1202		
Matsui	0012, 0442, 0512, 0522, 0812, 0972	Saisho	0162, 0202, 0292, 0442, 0512, 0522, 0972	Yoko	0012, 0062, 0072		
Medion	1142, 1162, 1172	Salora	0192, 0572, 0812, 0822, 0912				
Memorex	0012, 0132, 0432, 0482, 0532, 0572	Samsung	0052, 0072, 0652, 1192, 1212				
Metz	0062, 0092, 0932	Sansui	0042, 0142				
MGA	0912	Sanyo	0482, 0532, 0562, 0572				
Micromaxx	1142, 1162, 1172	SBR	0052, 0152, 0182				
Minerva	0062, 0092, 0252	Schaub Lorenz	0022, 0042				
Minolta	0172, 0602	Schneider	0002, 0012, 0052, 0072, 0432				
Mitsubishi	0052, 0062, 0142, 0912, 0922	SEG	0002, 0072				
MTC	0072, 0432	Sei-Simudyne	0442				
Multitech	0002, 0052, 0062, 0282, 0432	Seleco	0042				
Murphy	0432	Sentra	0112				
N.E.I.	0012, 0052	Sharp	0132, 0502, 0702				
National	0462	Shintom	0002				
NEC	0042, 0122, 0142, 1202	Siemens	0062, 0092, 0252, 0572				
Neckermann	0032, 0042, 0052, 0072, 0092, 0202, 0522, 0572, 0762, 0812	Sinudyne	0052, 0382, 0442, 0932				
Nikkai	0112	Sonoko	0282				
Nobliiko	0092	Sony	0432, 0552, 0682, 0692, 0942, 0952, 0962, 1122, 1132				
Nokia	0022, 0032, 0042, 0072, 0292, 0492, 0532, 0572, 0762, 1152						

LD PLAYER

Aiwa	0137
Funai	0137
Hitachi	0047
Magnavox	0077
Panasonic	0027
Pioneer	0037
Realistic	0137
Samsung	0017, 0087
Sony	0057, 0097, 0107, 0117
Victor	0127
Yamaha	0007

CD PLAYER

Accuphase	0315
Adc	0865
Adcom	0785, 1015
Akai	0115, 0125, 0725, 0735, 0745, 0935, 1155
Arcam	1875
Arcam-Rotel	0165
Audio-Technica	0835
Audiosonic	0155
Awia	1105, 1235, 1245, 1765, 1915, 1935
BSR	0875
California Audio Lab	1075
Carrera	0555, 0875
Carver	0825, 1415
Cyrus-Rotel	0205
Denon	0045, 0955, 1045, 1595, 1795, 1805
Dual	1005
Elin	0185
Emerson	1015, 1285, 1675
Fisher	0105, 0595, 0605, 0825, 1165, 1175
Genexxa	0525, 0825, 0855, 0875, 0995, 1265, 1285, 1345, 1355, 1485, 1575, 1675, 1715, 1825
GoldStar	0555, 1185, 1195, 1585
Grundig	0175
Harman Kardon	0495, 0565, 0325, 1135, 1145, 1155
Hitachi	0065, 0585, 0685, 0945, 1005, 1015, 1225, 1545
Innovation	1995, 2005, 2015
ITT-Nokia	0185
JVC (Victor)	0385, 0395, 0455, 0575, 0585
Karcher	0485
Kenwood	0025, 0055, 0145, 0215, 0595, 0675, 0695, 0705, 0715, 0925, 1355, 1485, 1575, 1675, 1715, 1825
Korting	0175
Lifetec	2015
Light Control	1155, 1645, 1655, 1665
Linn	0165, 1875
Luxman	0265, 0275, 0795, 0805, 1295, 1305, 1555, 1925
Luxor	0185, 1895, 1905
Magnavox	1865, 1875

DVD PLAYER

Akai	0108
Denon	0368
Hitachi	0388
JVC (Victor)	0168, 0348
Kenwood	0288
Magnavox	0248
Mitsubishi	0268
Onkyo	0128, 0248
Panasonic	0048
Philips	0188, 0248
Pioneer	0208, 0228
Proscan	0308
RCA	0067, 0308
Samsung	0148
Sharp	0068
Sony	0028
Technics	0048
Thomson	0328
Toshiba	0088, 0248
Yamaha	0008, 0048, 0188, 0248
Zenith	0248

Marantz 0165, 0175, 0545,
 0665, 1275, 1335,
 1405, 1505, 1875,
 1955
 Matsushita 1095, 1605
 MCS 0535
 Medion 0075, 1995, 2005,
 2015
 Memorex 0525, 1015, 1265,
 1275, 1285, 1675
 MGA 1125
 Micromaxx 2015
 Mission 0165, 1875
 Mitsubishi 1125, 1205
 NAD 0255, 0285, 0295,
 0305, 0345, 0135,
 0755, 0765, 1315,
 1325
 Nakamichi 0635, 0645, 1565
 NEC 0405, 0535, 0775,
 0785
 Neckerman 0155, 0225
 Nikko 0835, 1165
 Oceanic 0185
 Okano 0155, 0225
 Onkyo 0885, 1385, 1425,
 1455, 1515
 Panasonic 1055, 1075, 1615,
 1625
 Philips 0165, 0175, 0195,
 1865, 1875
 Pioneer 0095, 0335, 0425,
 0435, 0445, 0525,
 0855, 1035, 1945
 Proton 0905, 1875
 Quasar 1075
 Radiola 1845, 1855
 Radiotone 0485
 Realistic 0825, 1015, 1265,
 1275, 1285, 1575
 Rotel 1875
 Saba 1005
 SAE 1875
 Salora 0185
 Sansui 0415, 0965, 0975,
 0985, 1255, 1675,
 1875
 Sanyo 0625, 0825, 0845,
 0915
 Schneider 1845, 1855
 Scott 1285, 1675
 Sharp 0025, 0035, 1025,
 1115, 1275, 1635,
 1785, 1815, 1825,
 1835
 Sherwood 1275, 1445
 Siemens 1085
 Signature 1155
 Sony 0345, 0355, 0365,
 0375, 0865, 1685,
 1695, 1705, 1715,
 1725, 1735, 1745
 Sytvania 1875
 Tandberg 1885
 Tashiko 1525
 TCM 1985, 2015
 Teac 0235, 0245, 1275,
 1365, 1375, 1395,
 1435, 1465, 1475
 Technics 0465, 0475, 1065,
 1075, 1625
 Telefunken 1005
 Theta Digital 1865
 Thomson 1005
 Toshiba 0755, 0765

Vector Research 0555, 0865
 Yamaha 0005, 0015, 0085,
 0345, 0615, 0655,
 0815, 0835, 0895

CD-RECORDER/CD-RW

Hitachi 0304
 JVC (Victor) 0334
 Marantz 0314, 0324
 Philips 0274
 Pioneer 0284, 0294
 Yamaha 0244

MD RECORDER

Kenwood 0214
 Pioneer 0254
 Sharp 0264
 Sony 0224
 Yamaha 0024, 0224, 0234

TAPE DECK

Akai 0124
 Denon 0204
 Grundig 0134
 Harman 0044
 JVC (Victor) 0194
 Kenwood 0164
 Korting 0134
 Luxman 0054, 0064, 0074,
 0084
 Marantz 0134, 0144
 NAD 0174
 Onkyo 0184
 Philips 0134, 0144, 0154
 Pioneer 0034, 0114
 Sony 0094, 0104
 Yamaha 0004, 0014



YAMAHA ELECTRONICS CORPORATION, USA 6660 ORANGETHORPE AVE., BUENA PARK, CALIF. 90620, U.S.A.
YAMAHA CANADA MUSIC LTD. 135 MILNER AVE., SCARBOROUGH, ONTARIO M1S 3R1, CANADA
YAMAHA ELECTRONIK EUROPA G.m.b.H. SIEMENSSTR. 22-34, 25462 RELINGEN BEI HAMBURG, F.R. OF GERMANY
YAMAHA ELECTRONIQUE FRANCE S.A. RUE AMBROISE CROIZAT BP70 CROISSY-BEAUBOURG 77312 MARNE-LA-VALLEE CEDEX02, FRANCE
YAMAHA ELECTRONICS (UK) LTD. YAMAHA HOUSE, 200 RICKMANSWORTH ROAD WATFORD, HERTS WD1 7JS, ENGLAND
YAMAHA SCANDINAVIA A.B. J A WETTERGRENS GATA 1, BOX 30053, 400 43 VÄSTRA FRÖLUNDA, SWEDEN
YAMAHA MUSIC AUSTRALIA PTY, LTD. 17-33 MARKET ST., SOUTH MELBOURNE, 3205 VIC., AUSTRALIA

YAMAHA CORPORATION
Printed in Malaysia ID V735940

Connection Guide (when listening to a digital 5.1-channel source)

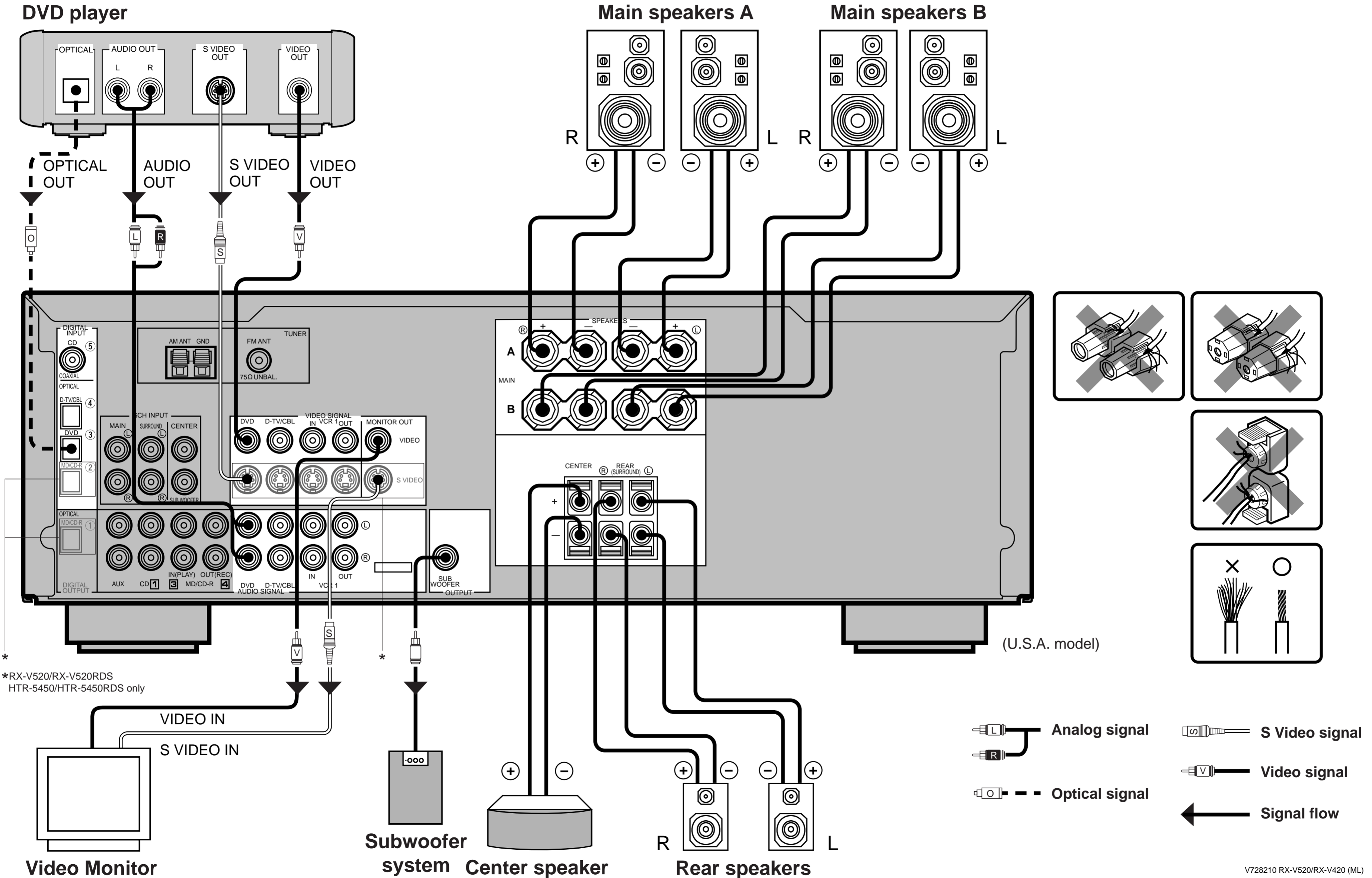

*RX-V520/RX-V520RDS
HTR-5450/HTR-5450RDS only

Quick Reference Card

AMP(TUNER)

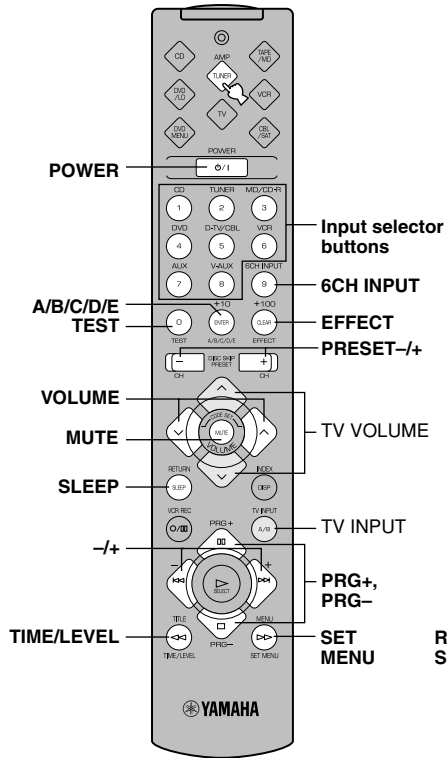

TAPE/MD

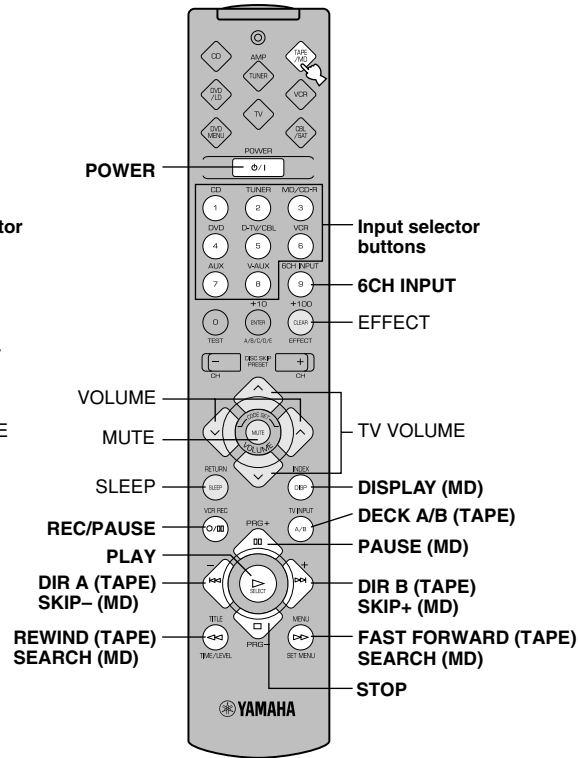

CD

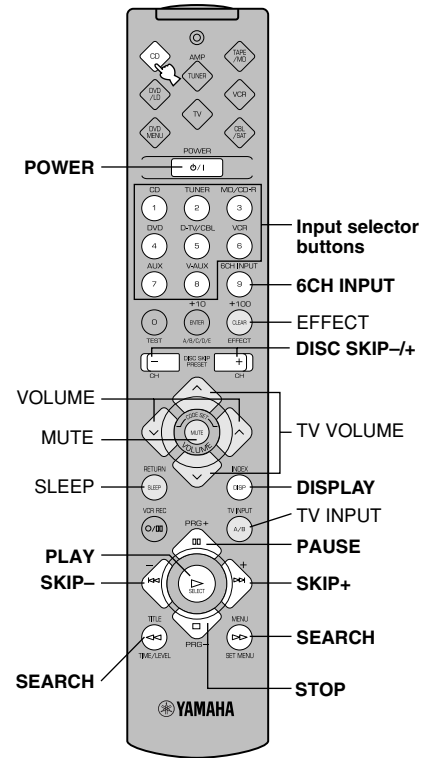

DVD/LD

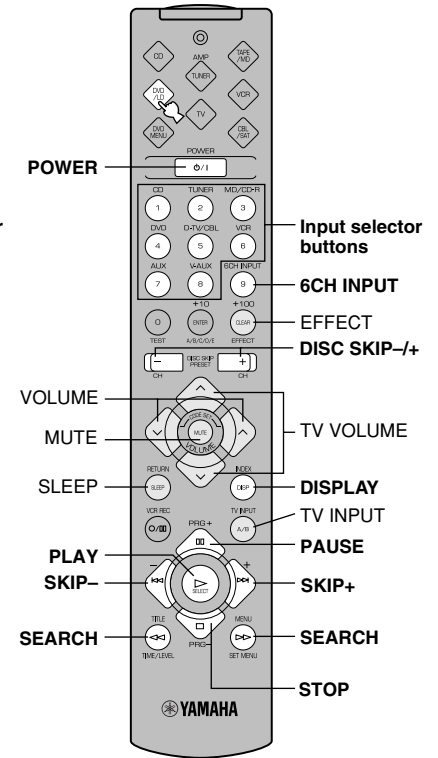

Quick Reference Card

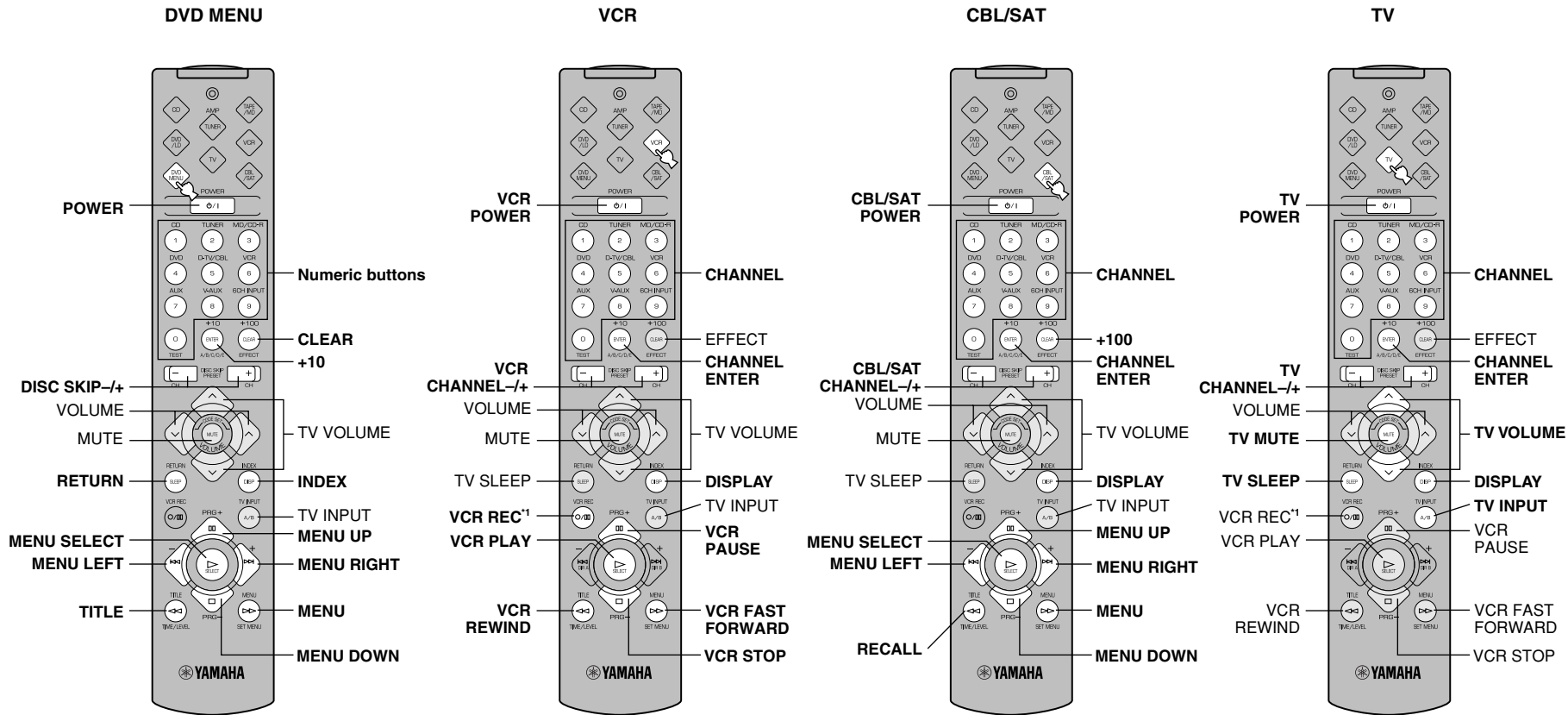

*1 Press this button twice to start recording.
 Appuyer deux fois sur cette touche pour commencer l'enregistrement.
 Drücken Sie diese Taste zweimal, um die Aufnahme zu starten.
 Tryck två gånger på den här knappen för att börja spela in.

Premere due volte questo tasto per iniziare la registrazione.
 Presione dos veces este botón para empezar a grabar.
 Druk tweemaal op deze toets om met opnemen te beginnen.
 按此按钮两次即可开始录像。